



Voice Channel™

Tube Channel Strip with Digital Connectivity

USER'S GUIDE



IMPORTANT SAFETY INSTRUCTIONS – READ FIRST



This symbol, wherever it appears, alerts you to the presence of uninsulated dangerous voltage inside the enclosure. Voltage that may be sufficient to constitute a risk of shock.



This symbol, wherever it appears, alerts you to important operating and maintenance instructions in the accompanying literature. Please read manual.

Read instructions:

Retain these safety and operating instructions for future reference. Heed all warnings printed here and on the equipment. Follow the operating instructions printed in this user guide.

Do not open:

Aside from one vacuum tube, there are no user serviceable parts inside. Refer any service work to qualified technical personnel only.

Power sources:

Only connect the unit to mains power of the type marked on the rear panel. The power source must provide a good ground connection.

Power cord:

Use the power cord with sealed mains plug appropriate for your local mains supply as provided with the equipment. If the provided plug does not fit into your outlet consult your service agent. Route the power cord so that it is not likely to be walked on, stretched or pinched by items placed upon or against.

Grounding:

Do not defeat the grounding and polarization means of the power cord plug. Do not remove or tamper with the ground connection on the power cord.

Ventilation:

Do not obstruct the ventilation slots or position the unit where the air required for ventilation is impeded. If the unit is to be operated in a rack, case or other furniture, ensure that it is constructed to allow adequate ventilation.

Moisture:

To reduce the risk of fire or electrical shock do not expose the unit to rain, moisture or use in damp or wet conditions. Do not place a container of liquid on it, which may spill into any openings.

Heat:

Do not locate the unit in a place close to excessive heat or direct sunlight, as this could be a fire hazard. Locate the unit away from any equipment, which produces heat such as: power supplies, power amplifiers and heaters.

Environment:

Protect from excessive dirt, dust, heat, and vibration when operating and storing. Avoid tobacco ash, drink spillage and smoke, especially that associated with smoke machines.

Handling:

To prevent damage to the controls and cosmetics avoid rough handling and excessive vibration. Protect the controls from damage during transit. Use adequate padding if you need to ship the unit. To avoid injury to yourself or damage to the equipment take care when lifting, moving or carrying the unit.

Servicing:

Switch off the equipment and unplug the power cord immediately if it is exposed to moisture, spilled liquid, objects fallen into opening, or the power cord or plug becomes damaged during a lightning storm or if smoke odor or noise is noted. Refer servicing to qualified technical personnel only.

Installation:

Install the unit in accordance with the instructions printed in the user guide.

Voice Channel™

Tube Channel Strip with Digital Connectivity

IMPORTANT SAFETY INSTRUCTIONS – READ FIRST	1
INTRODUCTION	4
INSTALLATION	4
AC Power Hookup	4
Analog Audio Connections	4
FRONT PANEL CONTROLS and JACKS	5
Mic Preamp Controls	5
Instrument Input	5
Gain Control	5
Impedance Control	5
Pad Switch	5
Phantom Power	5
Invert Switch	5
Low Cut Switch	5
Tube Voltage Switch	6
Dynamic Processor Controls	7
Threshold Control	7
Ratio Control	7
De-esser Control	7
De-esser Freq. Control	7
Attack Control	7
Release Control	8
Gain Reduction LED Meter	8
Expander/Gate Switch	8
Expander/Gate Threshold Control	8
Semi-Parametric EQ	9
EQ Position Switch	9
EQ Bypass Switch	9
Output Level Control	10
Output Level Meters	10
Sample Rate/Dither Control	11
Optical Output Switch	11
REAR PANEL CONNECTIONS	12
Mic/Line Input	12
Mic Preamp Output	12
Insert Input	12
Balanced Output	12
A/D Main Insert and A/D CH2 Insert	12
Wordclock Input and Thru Jacks	12
ADAT Input Jack	13
Optical Output Jack	13
S/PDIF Output Jack	13
AES/EBU Output Jack	13
USB Jack	13
APPLICATIONS	14
Bypassing Components Of The Voice Channel™	14
Optimizing The Preamp For Lowest Noise	14
Utilizing Pre/Post Compression EQ	14
WARRANTY INFORMATION	15
SERVICE	16
SPECIFICATIONS	17

LIST OF FIGURES

FIGURE 1 – Preamp section	6
FIGURE 2 – Dynamics Section.....	6
FIGURE 3 – Equalizer Section	9
FIGURE 4 – Signal Flow Block Diagram	10
FIGURE 5 – Output Section	11
FIGURE 6 – Rear Panel	11
FIGURE 7 – Wordclock Termination	13

INTRODUCTION

The ART Voice Channel™ is the answer to your recording and computer audio interface needs. Our second-generation discrete Class-A microphone preamp provides clean quiet gain while maintaining incredible transparency. A powerful dynamics processor subtly controls transients and noise of the most demanding sources. The ART Voice Channel's semi-parametric EQ offers wide tune-ability and can be patched before OR after the dynamics processor. Separate insertion jacks allow you to use your favorite external signal processing gear immediately after the Mic preamp and before the EQ and dynamics processor. Another patch point exists just before the A/D converters. Choose between a wide range of outputs including balanced analog output, 44.1 KHz to 192 KHz AES/EBU, S/PDIF, ADAT and USB. Both analog and digital meters provide a detailed indication of audio levels.

INSTALLATION

The ART Voice Channel™ may be used in a wide variety of applications and environments. In a rack-mountable, all-steel enclosure, the unit is designed for continuous professional use. Mounting location is not critical, however for greater performance reliability we recommend that you not place the unit on top of power amps, or other sources of heat and/or strong magnetic fields. The tube circuitry needs about a minute to “warm up” and stabilize from a cold power up.

AC Power Hookup

The ART Voice Channel™ has an internal power supply. Only connect the unit to mains power of the type marked on the rear panel. The power source must provide a good ground connection, and the ground pin on the mains plug should never be defeated.

Analog Audio Connections

Audio connections to and from the Voice Channel™ are:

Front panel balanced combo input: [XLR] Pin 2 = Hot (+), Pin 3 = Cold (-), Pin 1 = Ground
[1/4"] Tip = Hot (+), Sleeve = Ground

Rear panel balanced combo input: [XLR] Pin 2 = Hot (+), Pin 3 = Cold (-), Pin 1 = Ground
[1/4"] Tip = Hot (+), Ring = Cold (-), Sleeve = Ground

Rear panel balanced 1/4" output: Tip = Hot (+), Ring = Cold (-), Sleeve = Ground

Rear panel 1/4" insert input: Tip = Hot (+), Sleeve = Ground

Mic Preamp Output: Tip = Hot (+), Sleeve = Ground

A/D Main & A/D CH2 Inserts: Tip = Input, Ring = Output, Sleeve = Ground

FRONT PANEL CONTROLS and JACKS

Mic Preamp Controls

The Voice Channel™ input consists of a discrete Class-A differential preamp. The circuit is optimized for low impedance microphones as well as line level signals. Up to 60dB of gain is available from this stage. The output can be inverted using the INVERT switch.

The impedance of the front and rear XLR inputs is continuously variable for fine-tuning the preamp to a wide variety of mics. Phantom power is available on the XLR inputs as well.

A selectable low-cut filter removes rumble, wind noise, and pops, thereby increasing clarity.

Instrument Input

The 1/4" T/S jack on the front panel provides a high impedance unbalanced input, and when used, automatically switches off the mic pre-amp. (The rear combo jack's 1/4" T/R/S balanced input is lower impedance and is part of the mic pre-amp. The rear jack is not intended to be used with high impedance microphones or instruments.) NOTE: When using the INSTRUMENT INPUT, the PAD switch is disabled and does NOT affect the gain.

Gain Control

This control adjusts both the mic pre-amp gain as well as the instrument input gain. The gain marked applies to the mic pre-amp without the PAD switch depressed. The instrument input gain markings are on the right side of the slash (/). Refer to the APPLICATIONS section to learn how to optimize the gain control for low noise operation.

Impedance Control

This knob sets the load impedance at the front and rear panel XLR inputs of the Voice Channel™. Use the IMPEDANCE CONTROL to subtly tune the sound of your microphone. Various microphones will change their sound at differing load impedances. The correct setting is subjective. Adjust this control to personal taste.

Pad Switch

This switch reduces the mic pre-amp gain by up to 20dB to prevent clipping when high level mic, or line level signals are applied to the balanced XLR or 1/4" T/R/S inputs. This switch does NOT affect the 1/4" T/S front panel INSTRUMENT INPUT.

Phantom Power

The switch safely applies +48Volt phantom power to the XLR inputs. Use phantom power only when the microphone that you are using requires it. Doing so will extend the life of the Voice Channel™ as well as reducing the possibility of shock hazard.

Invert Switch

This switch selects the output phase of the Voice Channel™. There is a 180 degree phase shift through the Voice Channel™ when lit.

Low Cut Switch

This switch inserts a 100Hz 6dB/Oct. Low-Cut filter into the signal path. The filter is designed to remove rumble, pops, and wind noise, yet still sound natural.

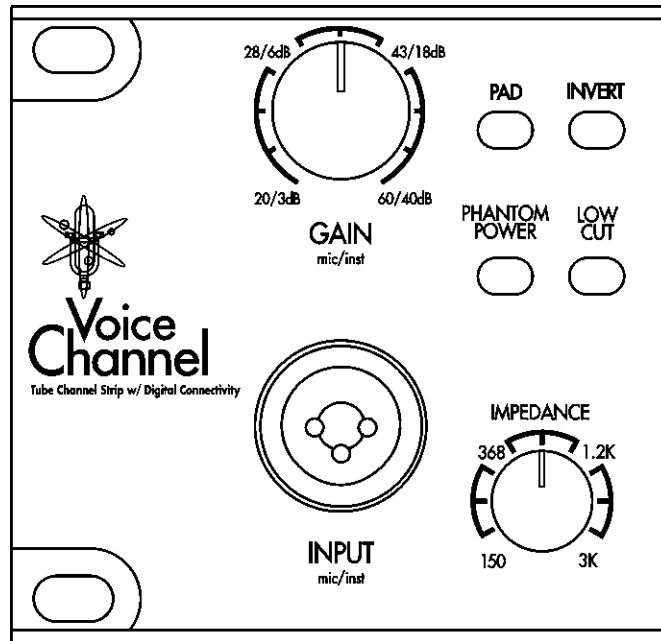

FIGURE 1 – Preamp section

Tube Voltage Switch

The vacuum tube preamp section can be adjusted to run at two different plate voltages. Refer to Figure 2 for the location of the switch.

Choose the “NORMAL” setting for adding warmth to the input signal. This setting has an increased amount of tube saturation at higher signal levels.

Choose the “HIGH” setting to increase overall gain, headroom, and bandwidth.

NOTE: The change between tube voltage modes is gradual, taking 10 to 20 seconds to be fully activated.

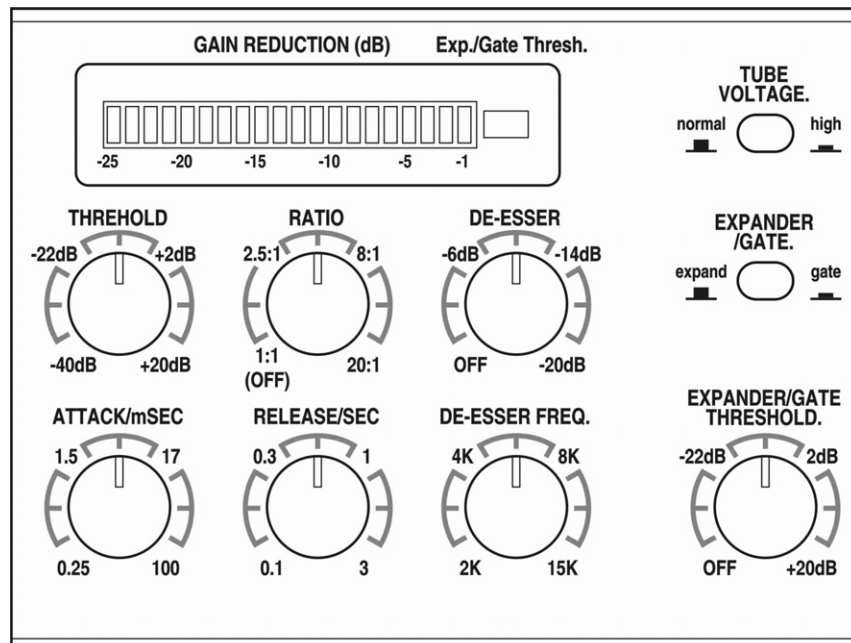

FIGURE 2 – Dynamics Section

Dynamic Processor Controls

The ART Voice Channel™ dynamics section consists of an above threshold Compressor/Limiter with De-esser plus a selectable Expander/Gate. The attack and release controls allow a wide range of adjustment while the complex detector assures fast response without distortion. The De-esser is frequency tunable.

Threshold Control

This control sets the level, above which the Compressor/Limiter in the Voice Channel™ starts to act on the input signal. As the control is turned clockwise, more input signal is required to begin reducing gain. The compression action can be seen in the Gain Reduction LED meter.

Ratio Control

The RATIO control sets the amount of gain reduction that takes place based on how far the input signal is over the threshold level (set by the THRESHOLD control). **When the control is fully counterclockwise, the Compressor/Limiter is OFF.**

A good starting point for vocals is 2.5:1.

To have the unit act as a limiter, set the RATIO control to 20:1.

De-esser Control

The DE-ESSER control sets how much more the gain is reduced at high frequencies when using the Compressor/Limiter. The most common application is reducing sibilance when compressing vocals. When fully counterclockwise, the De-esser function is OFF. As the control is turned clockwise, high frequency material is compressed more than mid and low frequency material.

De-esser Freq. Control

This control selects which high frequencies the DE-ESSER acts upon. Turned fully counterclockwise, the DE-ESSER acts on the upper mid-range. When set fully clockwise, only the highest frequencies are reduced more during de-essing compression. Center the DE-ESSER FREQ. control as a starting point for vocal work.

Attack Control

The ATTACK control sets the time it takes the Compressor/Limiter to respond to increases in signal level (by reducing gain). You can use this control to shape the “front end” of the dynamics envelope.

One example is to listen to a snare hit and adjust the attack control. A short attack makes the snare sound “thin”. As the attacks go longer (and the knob is turned clockwise) you should hear more of the thump in the compressed snare. The downside is that this creates an overshoot, (a large transient), the length of which is the time set by the ATTACK control.

Overshoots less than 1 msec are very hard to hear even when they are clipped. If the attack is set too fast, the gain may be reduced too much and thereby create a “pumping” sound¹. One way to eliminate this is to use the LOW CUT filter to remove plosive sounds in vocals that can make the detector overreact.

¹ “Pumping” in a Compressor/Limiter sounds like the signal is muted when it shouldn’t be.

Release Control

The RELEASE control sets the time the Compressor/Limiter takes to increase the gain after the input level drops.

Longer settings maintain the dynamics of the input signal, while shorter settings reduce the dynamics. Shorter settings will also increase the apparent reverberation, and at extreme gain reduction settings, lead to “breathing” artifacts²

Gain Reduction LED Meter

The GAIN REDUCTION meter displays the Compressor/Limiter’s attenuation action. The meter covers a very large range while offering high resolution.

The large yellow LED at the right-hand end of the meter indicates Expander or Gate action. The brightness of the LED indicates the amount of gain reduction for the Expander function. Since the Gate is either ON or OFF, there is no brightness variation.

Expander/Gate Switch

This switch allows the selection of the Expander or the Gate functions. Both are useful in reducing unwanted background noise in the audio signal.

In the “OUT” position the Expander function is selected. Use this mode to gradually reduce background noise and maintain some of the input dynamics. This is useful for instruments with gradually decaying amplitude envelopes.

Depress this switch to select the Gate mode. This mode quickly cuts off the noise as the input signal drops.

Expander/Gate Threshold Control

The Expander/Gate action begins below the level indicated by the EXPANDER/GATE THRESHOLD control. The EXPANDER/GATE THRESH. LED in the GAIN REDUCTION display will light when the Expander or Gate attenuates the input signal.

The Expander/Gate Threshold detector has built-in hysteresis, which causes the unit to trigger “ON” at a higher level than the level required to trigger back to the “OFF” state.

The Expander slope is about 1:1.5. This is subtle enough to maintain the decay envelope of the source material and still lower the noise as the input signal drops. The EXPANDER/GATE THRESH. LED will light dimly for the first 5dB of gain reduction, and then glow brightly as the attenuation increases above this level.

The Gate function has an intelligent detector with a fast “attack” and “release”, coupled with a program dependant “hold”. The hold time is longer for sustained passages and shorter for transients. As the input drops below the threshold and the input signal is muted, the EXPANDER/GATE THRESH. LED lights brightly.

You can turn off the Expander/Gate function by setting the THRESHOLD control fully counterclockwise to “OFF”.

² “Breathing” is the sound of the Compressor/Limiter turning up the gain so quickly you can hear breathing noises between words during vocal processing.

Semi-Parametric EQ

The ART Voice Channel™ offers a four-band semi-parametric equalizer. The EQ can be bypassed as well as positioned before or after the dynamics processing section. Each band has $\pm 15\text{dB}$ of control range.

The High and Low EQ bands are shelving type with a switch selectable turnover point.

The two Mid bands can be continuously tuned over a five octave range.

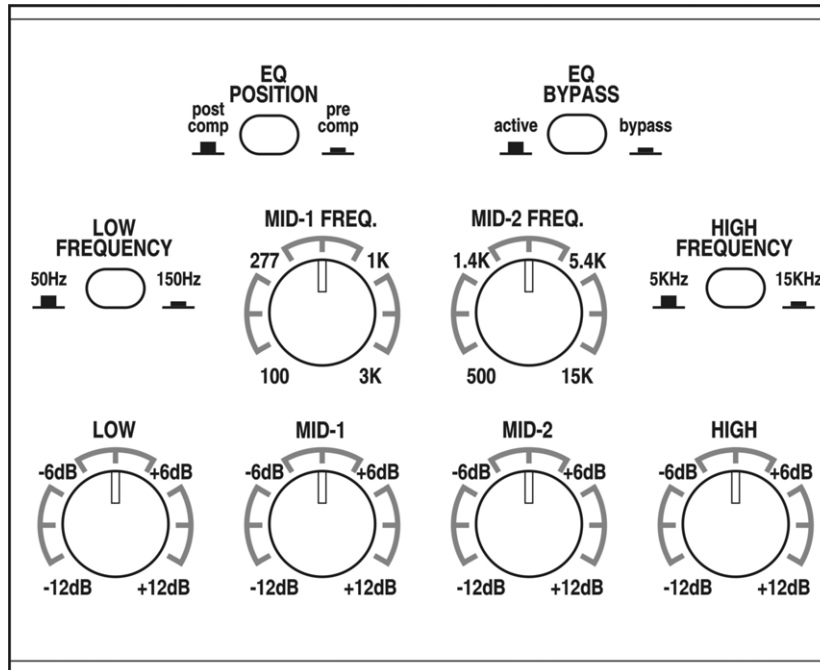

FIGURE 3 – Equalizer Section

EQ Position Switch

The EQ POSITION switch allows you to connect the EQ before or after the dynamics processing block. This is useful in cases where the input signal needs a great deal of EQ before the Compressor/Limiter processes it. One example of using the EQ in the “PRE” position is using the LOW EQ control as a tunable low frequency cut, supplementing the LOW CUT filter switch.

Refer to Figure 4 for the block diagram of the Tube Channel. Note that the Mic preamp insert jack function is located before the EQ position switch.

EQ Bypass Switch

This switch allows you to instantly set the EQ completely flat without losing the current EQ settings.

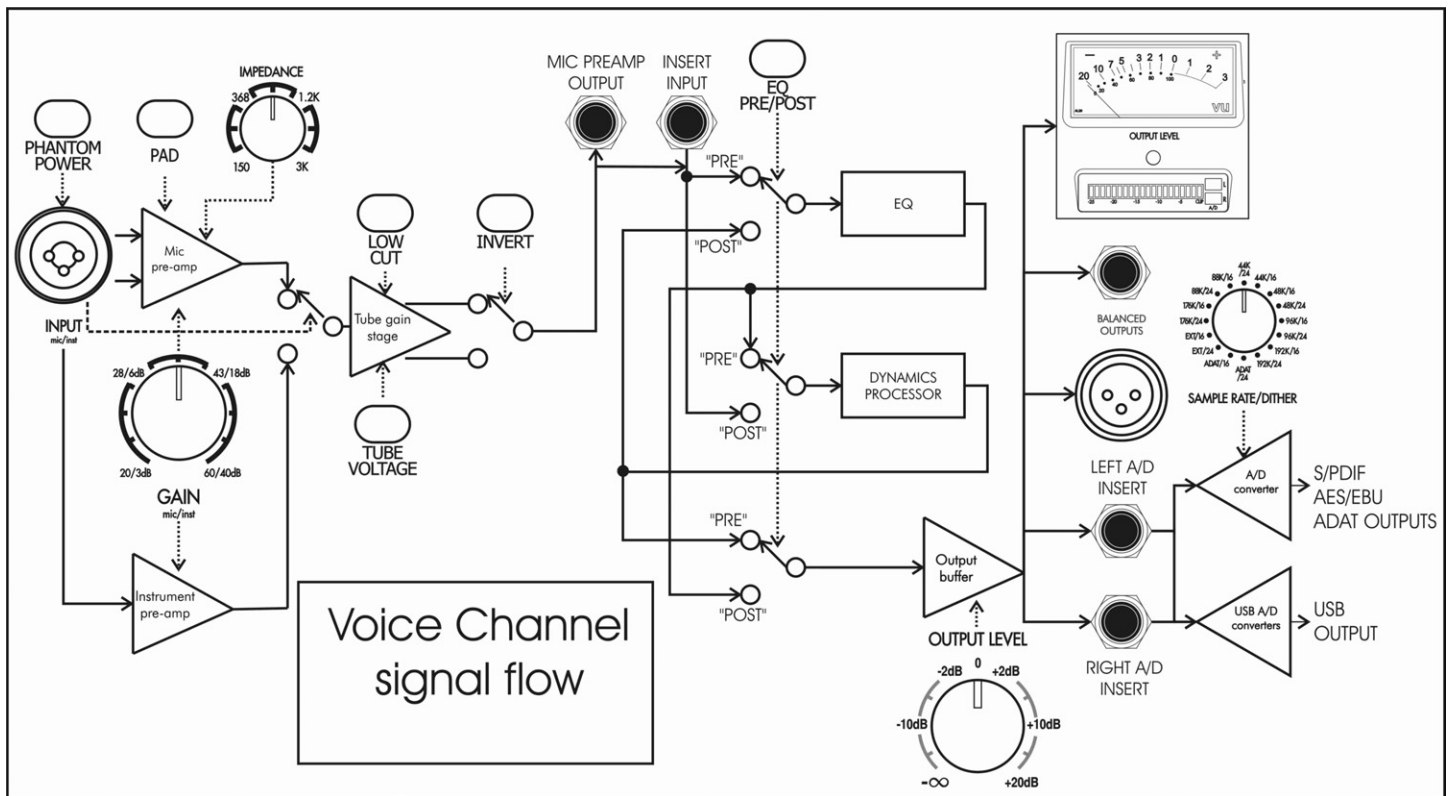

FIGURE 4 – Signal Flow Block Diagram

Output Level Control

The OUTPUT LEVEL control provides gain or attenuation to adjust for a variety of system operating levels. This control affects the levels sent to the A/D converter and to the balanced analog OUTPUT jacks.

Output Level Meters

The ART Voice Channel™ provides both analog and digital output meters. The meters monitor the signal level just after the output control. This signal is sent to both the analog and digital outputs.

“0” VU on the analog VU meter corresponds to +4dBu on the balanced outputs, and about –20dB on the LED bargraph meter.

The LED bargraph meter indicates peak levels as well as average levels. Average levels are indicated by a continuous string of LEDs being lit. Peak levels are indicated by a single LED and are held for about 2 seconds. The last LED in the meter is marked “Clip”, and it indicates that the output level is set too high.

The A/D Clip indicator LEDs act independent of the OUTPUT LEVEL meter. This provides an accurate indication of A/D converter clipping. This is useful when using the A/D insertion jacks, since the level at the converters will not be indicated on the main meters when these inputs are used.

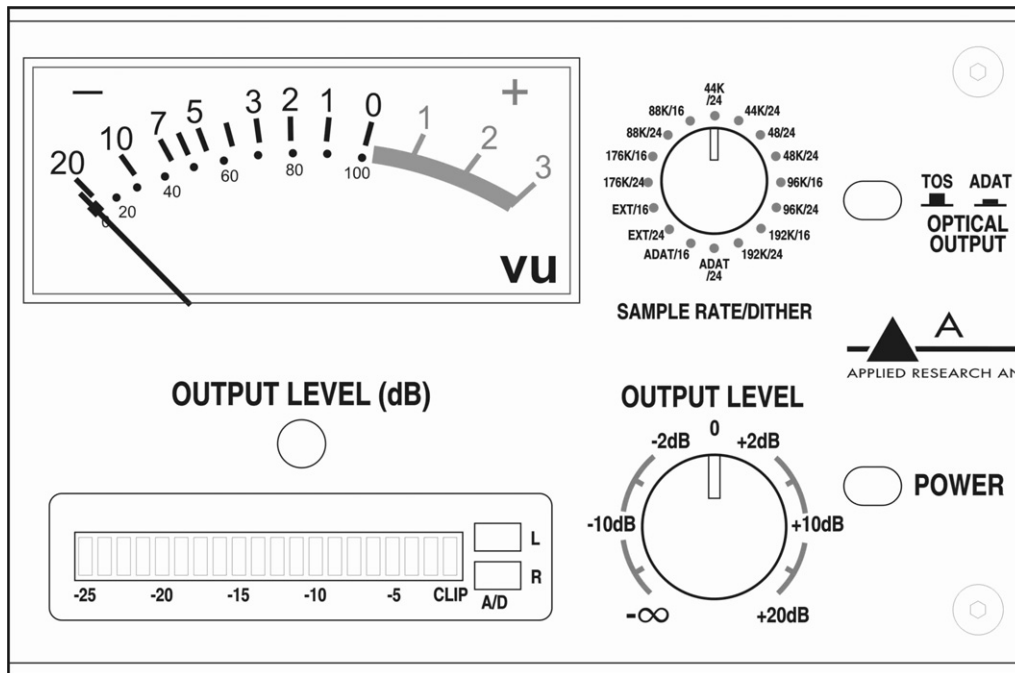

FIGURE 5 – Output Section

Sample Rate/Dither Control

The SAMPLE RATE/DITHER knob selects the sample rate for the AES/EBU, S/PDIF, and optical outputs. It also selects the dither applied. Set the switch appropriately to match up with 16 or 24 bit encoding.

NOTE: This control does NOT affect the USB output.

Optical Output Switch

The OPTICAL OUTPUT switch sets the signal format of the rear panel OPTICAL OUTPUT connector. In ADAT mode channels 1 and 2 are the “left” and “right” A/D outputs of the Voice Channel™ respectively. **NOTE:** If the A/D insertion jacks are not being used, both channels 1 and 2 carry the same signal. If the ADAT INPUT is also being used, channels 3 thru 8 are passed through along with channels 1 and 2 of the ART Voice Channel™.

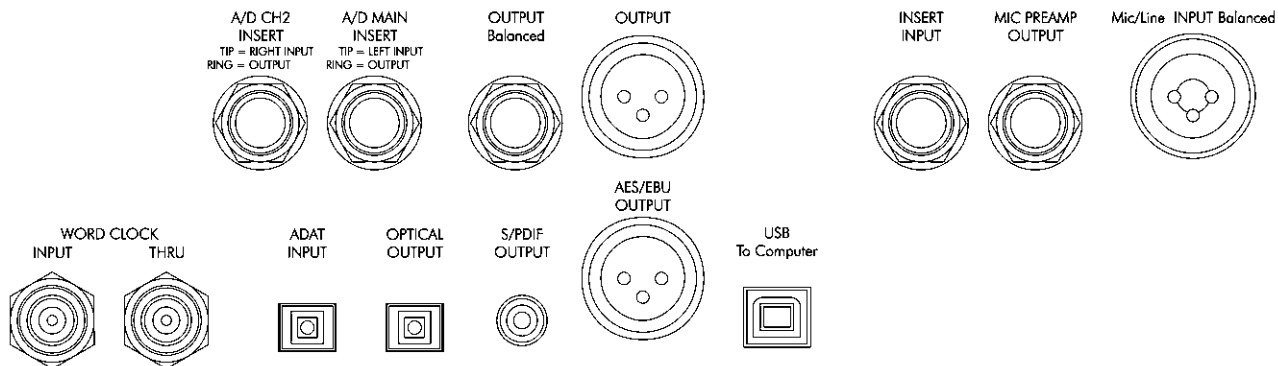

FIGURE 6 – Rear Panel

REAR PANEL CONNECTIONS

Mic/Line Input

This “combo” jack provides balanced inputs to the microphone preamplifier. The XLR connection is in parallel with the front input jack XLR. The input impedance of both XLR connections is variable by the front panel Impedance knob.

The rear 1/4” input of the combo jack overrides the front panel XLR input when used. This input’s impedance is NOT affected by the front panel Impedance control and is fixed at 20K Ohms.

The Front panel Instrument input overrides the rear jack when it is used.

Mic Preamp Output

This 1/4” T/S unbalanced jack provides a direct signal from the microphone preamplifier, ahead of the EQ and dynamics processors. This output can be used in conjunction with the INSERT INPUT jack to insert external signal processors between the main preamp section and the EQ and dynamics processing of the Voice Channel™.

Insert Input

This 1/4” T/S unbalanced jack is an input to the EQ and dynamics processing sections. This input can be used in conjunction with the MIC PREAMP OUTPUT jack to insert external signal processors between the main preamp section and the EQ and dynamics processing of the Voice Channel™.

Balanced Output

The analog output of the Voice Channel™ is available on both a 1/4” TRS balanced jack and an XLR jack. This output is active balanced, and will adjust to balanced or unbalanced termination without gain change. The LED and analog meter monitor the level present at this output. “0” VU on the analog meter corresponds with +4dBu (about 1.2 Volts RMS).

A/D Main Insert and A/D CH2 Insert

Signal processing can be added between the analog output of the Voice Channel™ and the “left” and “right” channels of the A/D converter by using the A/D MAIN INSERT and the A/D CH2 INSERT respectively. Use a 1/4” T/R/S (stereo) cable. The Ring is the output of the preamp and the Tip is the input to the A/D converter.

In order to use just the A/D converter and not the Voice Channel™ preamp, simply plug a standard 1/4” T/S phone cable into either A/D insertion jack.

Wordclock Input and Thru Jacks

The WORDCLOCK INPUT is used to externally sync the Voice Channel™ to a master clock source. The BNC WORDCLOCK INPUT jack is connected directly to the BNC WORDCLOCK THRU jack, providing the ability to loop through the Voice Channel™ and connect other devices to the wordclock sync source, saving the use of a BNC T–adapter.

The input is high impedance thus leaving the wordclock connection **unterminated**. (A 75 Ohm BNC terminator should be used on the WORDCLOCK THRU jack if the WORDCLOCK INPUT jack is used only by itself.)

Select the EXT/16 or EXT/24 sample rate setting on the front panel to utilize External Wordclock mode.

Refer to FIGURE 7 for wordclock termination examples.

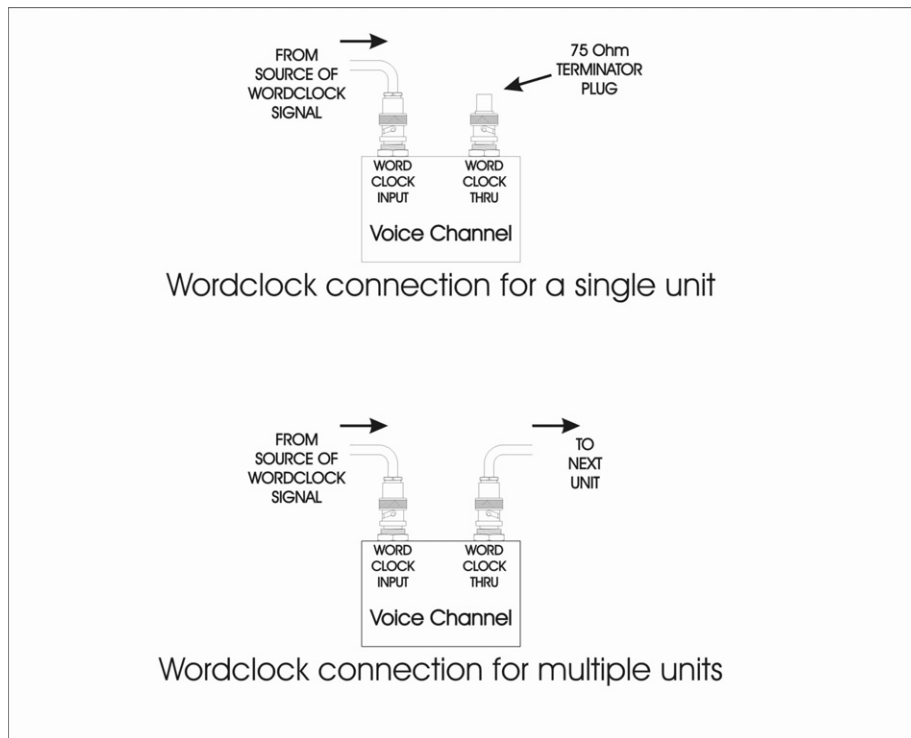

FIGURE 7 – Wordclock Termination

ADAT Input Jack

The optical ADAT input allows the Voice Channel™ A/D converter to synchronize to systems using ADAT optical connections. The Voice Channel™ inserts its output in channels 1 and 2 of the ADAT stream while passing through channels 3 thru 8. Select ADAT/16 or ADAT/24 with the Sample Rate control on the front panel to enable this mode.

Optical Output Jack

The OPTICAL OUTPUT jack works in conjunction with the front panel OPTICAL OUTPUT switch, to output either an ADAT formatted signal or a TOS formatted signal. The front panel SAMPLE RATE/DITHER control sets the sample rate, dither, and sync source for this output.

S/PDIF Output Jack

This connector provides S/PDIF formatted digital outputs from the “left” and “right” A/D converters. The front panel SAMPLE RATE/DITHER control sets the sample rate, dither, and sync source for this output.

AES/EBU Output Jack

This connector provides AES/EBU signal level digital outputs from the “left” and “right” A/D converters. The front panel SAMPLE RATE/DITHER control sets the sample rate, dither, and sync source for this output.

USB Jack

The USB jack provides the output of the Voice Channel™ to a direct computer USB connection. The Voice Channel™ will be recognized as a standard audio device on the PC or Mac. The sample rate and bit depth of this interface is set by the computer and is independent of the front panel settings. The audio data formats are limited to 32 KHz, 44.1 KHz, 48 KHz, 16 or 24 bit encoding.

APPLICATIONS

Bypassing Components Of The Voice Channel™

To bypass the vacuum tube microphone preamp: Use the preamp INSERT INPUT jack.

To bypass the Compressor/Limiter: Set the RATIO control fully counterclockwise to 1:1.

To bypass the Expander/Gate: Set the EXPANDER/GATE THRESHOLD control fully counterclockwise to OFF.

To bypass the EQ: Use the EQ bypass switch.

Optimizing The Preamp For Lowest Noise

The preamp of the ART Voice Channel™ can be optimized for low noise by combining use of the PAD and Input GAIN control for mic and line level signals. NOTE: The PAD control has no effect on the INSTRUMENT INPUT (Front panel 1/4" input of the INPUT combo jack).

First, bypass the Compressor/Limiter, Expander/Gate and EQ. Next center the OUTPUT LEVEL control to "0" dB of gain. The OUTPUT LEVEL LED meter can now be used to correctly indicate the clip level of the input stage.

Second, start with the PAD in the "OUT" position and the GAIN control centered. Refer to the OUTPUT LEVEL LED meter's peak-hold function. Make sure that this meter never indicates clipping (the red LED is held on after a transient). The peak-hold indicator can be in the "yellow" range or in the -5dB range of levels.

If the signal level is too high, depress the PAD switch.

Third, adjust the GAIN control to keep the peak levels in the -5dB range of the OUTPUT LEVEL LED meter.

Utilizing Pre/Post Compression EQ

The Equalizer section of the Voice Channel™ can be applied either before OR after the Compressor/Limiter. This function is useful in getting the best performance out of the unit.

Setting the Equalizer to "PRE COMP" is useful when the input signal contains too much low or high frequency information. Compressors in general work best when the audio is equalized first. (This can also serve to better control signal overshoots to the A/D converters as well.)

One example is a vocal where the performer/microphone combination produces a "popping" sound, and when compressed, the Compressor/Limiter "pumps". Sometimes the use of the LOW CUT filter in the preamp section does not cut enough of this out, or cuts too much of the lower midrange out of the signal to be useful. Here, the EQ can surgically remove this information and better optimize the overall sound.

WARRANTY INFORMATION

Limited Warranty:

Applied Research and Technology will provide warranty and service for this unit in accordance with the following warrants:

Applied Research and Technology, (A R T) warrants to the original purchaser that this product and the components thereof will be free from defects in workmanship and materials for a period of three years from the date of purchase. Applied Research and Technology will, without charge, repair or replace, at its option, defective product or component parts upon prepaid delivery to the factory service department or authorized service center, accompanied by proof of purchase date in the form of a valid sales receipt.

Exclusions:

This warranty does not apply in the event of misuse or abuse of the product or as a result of unauthorized alterations or repairs. This warranty is void if the serial number is altered, defaced, or removed.

A R T reserves the right to make changes in design or make additions to or improvements upon this product without any obligation to install the same on products previously manufactured.

A R T shall not be liable for any consequential damages, including without limitation damages resulting from loss of use. Some states do not allow limitations of incidental or consequential damages, so the above limitation or exclusion may not apply to you. This warranty gives you specific rights and you may have other rights, which vary from state to state.

For units purchased outside the United States, an authorized distributor of Applied Research and Technology will provide service.

SERVICE

The following information is provided in the unlikely event that your unit requires service.

- 1) Be sure that the unit is the cause of the problem. Check to make sure the unit has the proper power supplied, all cables are connected correctly, and the cables themselves are in working condition.
- 2) If you find the unit to be at fault, write down a complete description of the problem, including how and when the problem occurs.
- 3) Contact our Customer Service Department at (716) 297-2920 for your Return Authorization number or questions regarding technical assistance or repairs. Customer Service hours are 9:00 AM to 5:00 PM Eastern Time, Monday through Friday.
- 4) Pack the unit in its original carton or a reasonable substitute. The packing box is not recommended as a shipping carton. Put the packaged unit in another box for shipping. Print the RA number clearly on the outside of the shipping box. Print your return shipping address on the outside of the box.
- 5) Include with your unit: a return shipping address (we cannot ship to a P.O. Box), a copy of your purchase receipt, a daytime phone number, and a description of the problem.
- 6) Ship your unit (keep your manual!) to:

**Yorkville Sound
4625 Witmer Industrial Estates
Niagara Falls New York 14305
ATTEN: REPAIR DEPARTMENT**

RA# _____

Fill in the following information for your reference:

Date of purchase _____

Purchased from _____

Serial number _____

SPECIFICATIONS

Input Impedance

Mic.....	150 to 3.4K Ohms, variable
Line	20K Ohms
Instrument	2.5M Ohms
Preamp Insert.....	7.5K Ohms
A/D Inserts	10K Ohms

Output Impedance

Balanced Outputs.....	200 Ohms balanced
Preamp Output.....	100 Ohms
A/D Inserts	510 Ohms

Frequency Response

Analog In to Analog Out.....	12 Hz to 100 KHz +0, -1 dB
Analog In to Digital Out	12 Hz to 20 KHz +0, -1 dB @ 44.1 KHz sample rate
.....	16 Hz to 42 KHz +0, -1 dB @ 96 KHz sample rate

THD

1 KHz	≤ .015% typical
20 to 20 KHz	≤ .033% typical

Equivalent Input Noise

Mic/Line.....	-130 dBu, Input shorted, Max gain, "A" weighted
Instrument	-105 dBu, Input shorted, Max gain, "A" weighted

Maximum Input Level

Mic/Line.....	+18 dBu balanced with PAD
Instrument	+15 dBu

Maximum Gain

Mic.....	70 dB (XLR to balanced output)
Instrument	40 dB (1/4" to balanced output)

Maximum Output level

Balanced	+20 dBu
Unbalanced	+20 dBu
Output Level At Meter 0 VU	+4 dBu

Preamp

Microphone Gain.....	0 dB to +60 dB
Instrument Gain.....	+3 dB to +40 dB
Low Cut Filter	100 Hz, 1-pole, 6 dB/Octave

EQ

Boost/Cut	+12 dB on each band
Low Freq. Tuning	50/150 Hz Selectable
MID 1 Freq. Tuning	100 Hz to 3 KHz continuously variable
MID 2 Freq. Tuning	500 Hz to 15 KHz continuously variable
High Freq. Tuning	5K/15 KHz Selectable

Compressor/Limiter

Attack Time	250 uSec. to 100 mSec.
Release Time	100 mSec to 3 Sec.
De-esser Tuning.....	2.5 KHz to 15 KHz continuously variable
Compression Ratio.....	1:1 to 20:1
Expander Slope.....	1:1.5

Digital section

Wordclock Range.....	30 KHz to 204 KHz
Sample Rates.....	44.1 KHz, 48 KHz, 88.2 KHz, 96 KHz, 176 KHz, 192 KHz
A/D Dynamic Range.....	106 dB "A" weighted
USB A/D Dynamic Range	94 dB "A" weighted

Dimensions 3.50" H x 19.0" W x 9.17" D

Weight..... 10.5 lbs.

Power Requirements USA – 105 to 125 VAC/ 60 Hz Export units configured for country of destination.

USB Minimum System Requirements..... USB 1.1 compliant, Windows 98SE or newer, Mac OS 9.1 or newer

Note: 0 dBu = 0.775 VRMS, 0 dBV = 1 VRMS

ART maintains a policy of constant product improvement. ART reserves the right to make changes in design, or make additions to, or improvements upon, this product without any obligation to install same on products previously manufactured. Therefore, specifications are subject to change without notice.

NOTES



www.artproaudio.com
E-mail: support@artproaudio.com

© 2006 Applied Research & Technology

165-5004-103