

SGX
2000
EXPRESS

SGX
NIGHTBASS
STUDIO EDITION

SGX
NITRO

MULTIVERB
ALPHA
STUDIO EDITION

DR-X
2100
STUDIO EDITION

ATTACK
MODULE
K

THE PHANTOM

ART

DESIGNED AND MANUFACTURED IN THE USA

MDC-2001

USER'S GUIDE

TABLE OF CONTENTS

Section	Page
INTRODUCTION	2
MUTE	2
INPUT	2
OUTPUT	2
DETECTOR LOOP	2
GATE KEY INPUT	3
LIMITER LINK	3
GAIN CONTROL LED DISPLAY	3
INPUT/OUTPUT LED DISPLAY	3
THRESHOLD INDICATOR LED's	3
PEAK INDICATOR LED's	3
BYPASS INDICATOR LED	3
BYPASS SWITCH	3
OVERVIEW	4
BYPASSING AN INDIVIDUAL SECTION	4
COMPRESSOR	4
DE-ESSER	5
EXPANDER	5
NOISE GATE	5
EXCITER	6
PEAK LIMITER/CLIPPER	6
MASTER OUTPUT	6
SPECIFICATIONS	7
APPLICATIONS	8
WARRANTY INFORMATION	14
SERVICE INFORMATION	14

INTRODUCTION

Congratulations! You have just purchased what many professionals consider the finest, most technically advanced dynamics processor ever produced. We strongly suggest you read this manual and use it while you are getting familiar with all its functions and capabilities.

FEATURES

- Full stereo processing
- Advanced VCA circuitry
- Low noise design
- Separate output gain for each channel
- 100 ohm balanced outputs (XLR and 1/4")
- Switchable detector loop
- Separate Gate Key Input
- Limiter Link for ganging together more than one MDC-2001
- Switchable Input/Output metering

INSTALLATION

The MDC-2001 is designed for use in a wide variety of live and studio applications. Self contained in an all steel single space high 19" rack mount case, the MDC-2001 is designed for continuous professional use. For touring rack applications, care should be taken to support the unit's rear if the rack might be subjected to mechanical shock.

NOTE: The front panel may bend if no rear support is provided. Mounting location is not critical, but for greater reliability we recommend that you not place the unit on top of power amps, tube equipment, or other sources of heat.

The MDC-2001 does not have a power switch. This is because most applications will involve a multiple space rack system with a switched master AC mains power strip. The MDC-2001 was designed for this application and no harm will come to the unit when it is switched in this manner.

An audio mute circuit engages and disengages the outputs after the MDC-2001 has been turned on or off. The mute time is two to six seconds long after power up. Longer mute times are caused by lower AC mains voltage.

CONNECTIONS

All audio connections to the MDC-2001 are made at the rear of the unit via professional 1/4" phone jacks and XLR connectors.

INPUT

The audio inputs of the MDC-2001 are active balanced type with connections being made to either 1/4" stereo (TRS) jacks or standard XLR connectors. You may use the device in an unbalanced (single ended) configuration without harm to the device itself. Input impedance is 20K ohms balanced and 10K ohms if used unbalanced. Maximum input level is (+)20dBm.

Polarity for the 1/4" connector is: Tip = (+), Ring = (-), and Sleeve = ground. For the XLR connector polarity is: Pin 1 = ground, Pin 2 = (+), and Pin 3 = (-).

OUTPUT

The audio outputs of the MDC-2001 are active balanced type with connections being made to either 1/4" stereo (TRS) jacks or standard XLR connectors. You may use the device in an unbalanced (single ended) configuration without harm to the device itself or the following unit in the chain. Output impedance is 100 ohms balanced and 47 ohms if used un-balanced. Maximum output level is (+)24dBm.

Polarity for the 1/4" connector is: Tip = (+), Ring = (-), and Sleeve = ground. For the XLR connector polarity is: Pin 1 = ground, Pin 2 = (+), and Pin 3 = (-).

DETECTOR LOOP

Use:

The detector loop may be used for a variety of applications. Outboard de-essing, and ducking may be done by using the detector loop.

Operation:

When there is no connection made to the detector loop jacks, the detector loop is closed between the detector input and output jack. Connect the appropriate input and output of what you will use with the loop. To engage the detector loop input jack push the Detector Loop switch on the front panel in. The switch must be engaged for the detector loop to work. When the switch is out, the detector loop output signal is fed to the detector circuit.

Impedance of the Loop Input is 1K ohm. Loop Output impedance is 100 ohms.

The jack configuration for both input and output is: tip connections are the left detector and ring connections are the right detector. Of course, the sleeve is ground.

GATE KEY INPUT

The Gate Key Input is an outside link to the Gate detector circuit. A stereo jack is used to connect to each detector output. The tip and ring are connected separately to the left and right detector inputs respectively. When there is no connection made to the jack, the inputs are automatically connected due to the switching capabilities of the jack itself to the detector outputs.

Use the key input to trigger the gate from an external source. A line level audio signal may be used as a trigger. Input impedance is 1K ohm.

LIMITER LINK

The Limiter Link input enables you to connect multiple MDC's together. For linking three or more MDC's, a "Y" cord is needed. The limiter sections of the MDC's are linked and the operation of the limit LED's is maintained. The channel LED which causes the limiting action will be lit the brightest leaving the rest dimly lit. Input impedance for the Limiter Link is 1K ohm.

This input is a direct link to the VCA. A control voltage is either input or output from this jack. The larger of the control voltages has priority over what the limiter link acts as, the controller or controlled device. The limiter link is wire "or"ed to the VCA. Maximum VCA gain is set by the compressor threshold and slope. There is a 0.5 volt drop between the jack and VCA.

LED'S Gain Control Meter

The gain control meter consists of 21 LED's indicating a range of -30dB to +30dB and indicates exactly what is happening at the VCA. The center LED (0) is lit constantly indicating unity gain. Increased gain is indicated by lighting LED's to the right of unity. Decreased gain is indicated by LED's to the left of unity being lit. Since the display is always active, the controls of the MDC can be adjusted while the processor is bypassed.

INPUT/OUTPUT METER

The switchable Input/Output meter consists of 8 LED's per channel indicating a range from -30dB to +15 dB of level. The two LED's to the left of the meter indicate whether you are viewing input or output level.

Input level being displayed is shown when the yellow LED above the meter select switch is lit. Output level is displayed when the red LED is lit.

THRESHOLD INDICATORS

All functions of the MDC-2001 (except the De-Ess) are indicated they are in use by their yellow threshold indicators. When the set threshold of the effects audio signal level is reached the led will light. The compressor LED will light with no compressor action.

PEAK INDICATORS

The left and right peak indicators light when the audio signal level reaches the value you set with the peak limiter. One of the LED's, (if lit) will usually be brighter than the other. The brighter led indicates which channel is being used to drive the detector circuit.

BYPASS INDICATOR

The red LED above the Bypass switch when lit indicates the MDC-2001 is bypassed. The unit is in the active mode when the LED is not lit.

BYPASS SWITCH

The Bypass switch on the front panel selects whether the MDC is in bypass or active mode. Bypass mode for the MDC-2001 is a hard bypass, meaning the input and output jacks are tied together directly through the switch.

OVERVIEW

The MDC-2001 Stereo Master Dynamics Controller is a versatile component ready to add flexibility but more importantly control to your existing sound setup. Be warned, the MDC-2001 is not an effect, it is a tool to process your sound into the cleanest quietest productions you can imagine.

The MDC-2001 is a true stereo processor with individual isolated circuitry for two channel performance. The stronger signal of the two channels is used to determine the control parameters for the MDC's performance characteristics. Front panel controls affect the operation of both channels.

There are six user controllable processing devices contained in the MDC-2001. These include a compressor, de-esser, expander, noise gate, exciter, and peak limiter/clipper. Each play an important role in signal processing. Realistic practical controls are provided for each section allowing you to maintain precise and necessary mastering of the final sound.

Four separate detectors are used in the MDC-2001. The compressor and expander share the main detector, while the noise gate, exciter and limiter each have their own.

BYPASSING AN INDIVIDUAL SECTION

You may notice there are no in/out switches for the various sections. Each section becomes present in the path when the settings of the following controls are set greater than their minimum value.

Compressor: Ratio = 1:1
De-Esser: Level = 0
Expander: Slope = 1:1
Noise Gate: Thresh = (-)90
Exciter: Level = 0
Peak Limiter: Thresh = (+)20

When these controls are set at minimum, you should consider the section off.

PROCESSOR

COMPRESSOR

Controls:

Input (+)10 to (-)40
Ratio 1:1 to 40:1
Attack 0.5ms to 50ms
Release . . 0.1sec to 1.0 sec

Use:

A compressor is used to control the dynamic range of program material when a set threshold is exceeded.

Operation:

Four controls define the operation of the compressor. The controls, though independent in function, interact with each other to control the signal in the desired manner. The **Input** control sets the input sensitivity of the compressor. A threshold range from (-)40dB to (+)10dB is available. When the Input control is set to (+)10dB, the compressor is least sensitive, only signal levels above (+)10dB will be compressed. As the control is turned clockwise, input sensitivity increases. At the (-)40dB setting, any signal level greater than (-)40 dB will be compressed. The slope of the compressor is set with the **Ratio** control. The ratio range starts at 1:1 and has a maximum value of 40:1. A 4:1 ratio is achieved with the control set at 12 O'Clock. You should consider a 40:1 slope infinite, providing a compressed signal of a constant level regardless of the change in input signal level. With a 4:1 slope selected and the input level operating above the set threshold, a 4dB change in input level will result in only a 1dB change in output level.

Operating over a range of 0.5ms to 50ms, the **Attack** control sets the time it takes the compressor to respond to an increase in signal levels. When you use short attack times, the signal is well controlled but less dynamic. Short attack times are used to control transient signal levels. As the attack time is increased, dynamics become emphasized and the signal smooths over. Longer attack times respond mainly to the average signal level of the program material.

The **Release** control sets the amount of time the compressor takes to recover from a decrease in signal levels. Settable range is from 0.1 seconds to a full 1.0 second. A quick release time will increase the apparent level and decrease dynamics. If your release time is too quick for the program material you will hear the sound "pump". This is to say the output signal level will be uneven or jumpy. As the release time is lengthened, you maintain original dynamics and lower the average signal level. Both the attack and release controls also have an internal "Auto Adjust" feature dependent on the incoming audio signal. The two controls are fine tuned continuously by the dynamic characteristics of the audio signal.

How It Works:

At the heart of the compressor lies a Voltage Controlled Amplifier commonly known as a VCA. A VCA is a type of audio amplifier which was designed to be used to increase and decrease level. Instead of using signal attenuation, a VCA is controlled by an external DC voltage. This DC voltage is derived from a detector circuit which converts signal level into a DC voltage. Higher signal levels are converted into a higher DC voltage which drives the VCA harder providing attenuation.

DE-ESSER

Control:
Level...0dB to 15dB

Use:

A de-esser is used mainly to remove annoying sibilance when using large amounts of compression.

Operations:

Only one control is needed to operate the De-esser. **However, you must use the compressor section in order to use the de-esser.** The **Level** control sets the amount of signal used to control the detector circuit. The range of gain starts at 0dB and has a maximum value of 15dB. Adjust the level control until the desired amount of suppression is achieved.

How It Works:

The signal to be processed is fed to a band pass filter set at a certain frequency. The filtered signal is then fed to a log converter which in turn drives the compressor VCA. The control voltage derived from the VCA is used to control the circuitry necessary to suppress the frequency.

EXPANDER

Controls:
Thresh (-)50dBm to (+)20dBm
Slope 1:1 to 1:5

Use:

This expander is used mostly to reduce noise. It is commonly known as a downward expander. The best way to use the expander is in conjunction with the compressor. While there are lulls in the program material it will eliminate "noise swells" when the compressor is trying to level the signal when there is none to level.

Operation:

Set the **Threshold** control to the level you want the expander to start working from. When the signal level is less than the set threshold level, the expander LED will light indicating its presence in the signal chain and it is attenuating the signal. You will see the gain control LED's indicate this.

Adjust the **Slope** (depth) of the expander for the amount of gain reduction you desire. If your slope is set for a 1:2 ratio and you decrease the input level by 1dB, a reduction of 2dB will be the result on the output signal.

How It Works:

The signal level drives the main detector circuit. As the signal level decreases, the gain decreases.

NOISE GATE

Controls:

Thresh (-)90dBm to (+)20dBm
Hold Time . . . 15ms to 2sec

Use:

A noise gate is used to eliminate unwanted residual noise or low signal level when a certain minimum threshold level is passed.

Operation:

The noise gate is referenced to the input signal level. The **Threshold** control allows you to set the level at which the noise gate will kick in when the input level drops below it. When this threshold level is reached, the Noise Gate LED will light. A range from a minimum signal level of (-)90 dBm and maximum of (+)20dBm can be selected.

The time it takes the noise gate to react to the threshold level is settable with the **Hold Time** control. At shorter hold times, the noise gate will react quicker to the signal dropping lower than the threshold level causing the signal to be cut off more abruptly. At longer hold times, the gate attack is faster. [for 15ms hold time; attack is 5ms, greater than 100ms hold time; attack is .5ms]

How It Works:

Once the signal level falls below the threshold level a voltage is detected and sent to the VCA which in turn "closes the gate". The hold time control serves a dual purpose. First it holds the gate open a specific amount of time after the signal last passes above threshold. If the signal remains below the threshold after that time, the gate will close. If the signal goes above threshold, the gate remains open and waits for the signal to fall below threshold again. The second function of the hold time control is the attack or turn on time of the gate. After the gate is closed and the signal rises above threshold, the gate waits the specific time set with the control and then opens the gate. While the gate is open, it has no bearing on the VCA.

EXCITER:

Controls:

Level 0 to 10

Freq 4K to 15KHz

Use:

When you want to add more life, clarity, or bring out a specific frequency, use the exciter.

Operation:

First bring up the **Level** control to a nominal level. Select the approximate frequency you would like enhanced with the **Frequency** control. It is much easier to do this while listening to the program source. Re-adjust the Level control until you have the desired amount of enhanced sound. As the frequency is excited the LED will flash at varying intensities. Adjust the exciter so the LED is dimly lit during enhancement and pulses brightly on occasion. When the LED is brightly lit, it is indicating there is potential distortion present.

How It Works:

The exciter is an upward expander with a slope of 1:1.5 which brings out the dynamics in harmonics. High frequencies are first detected, then boosted. A high pass filter located first in the circuitry, allows only mid and upper frequencies to be excited.

PEAK LIMITER/CLIPPER

Control:

Threshold . . . 0dBm to (+)20dBm

Use:

A peak limiter is used to set a maximum desired level not to be exceeded in processing.

Operation:

Set the **Threshold** control to the desired maximum level you do not want to exceed. When the signal level reaches the set limit, the Peak LEDs will light. One LED will usually be brighter than the other. This indicates which channel is driving the detector. When the level reaches 6dB above the set limit level, the **clipping** circuit engages.

How It Works:

Attack time for the limiter is 100 to 300 microseconds (uS). Faster transients are clamped to 6dB above threshold during this time. The detector for the limiter actually monitors the output of the exciter and VCA before the output controls. This provides the user with complete output level control and protection. Be careful, if your Master Output controls are set for gain, you could encounter some clipping.

MASTER OUTPUT

Controls:

Left Channel (-)infinity to (+)6dB

Right Channel (-)infinity to (+)6dB

Use:

To set the master output level of the MDC-2001.

Operation:

Adjust the **Left and Right Channel** controls to determine the final output level of the processed signal. The range of level can be set from zero output level to a maximum output level of (+)6dB of gain.

SPECIFICATIONS

Frequency Response:.....16Hz to 28KHz, (+)0, (-).5dB
S/N Ratio.....(-)110dB
Dynamic Range:.....120dB
T.H.D.:.....(≤) 0.04% @1KHz
Maximum Input Level:.....(+20dBm
Input Impedance:.....20K ohm active balanced
Maximum Output:.....(+24dBm
Output Impedance:.....100 ohm active balanced
Mechanical:.....1.75" H x 19" W x 9.5" D
Weight:.....11.0 Lbs
Power:.....100-125 Volts AC, 60Hz, Internal fuse, 15W typical
(Export unit configured for destination country)

Compressor:

Threshold:.....(-)40dB to (+)10dB
Ratio:.....1:1 to 40:1
Attack:.....0.5ms to 50ms
Release:.....0.1sec to 1.0sec

De-Esser:

Level:.....0dB to 15dB

Expander:

Threshold:.....(-)50dBm to (+)20dBm
Slope:.....1:1 to 1:5

Noise Gate:

Threshold:.....(-)90dBm to (+)20dBm
Hold Time:.....15ms to 2.0sec

Exciter:

Level:.....0 to 10
Frequency:.....4KHz to 15KHz

Peak Limiter Clipper:

Threshold:.....0dBm to (+)20dBm
Clip:.....(+6dBm above set level
Attack Time:.....300uS maximum
Release Time:.....Program dependent

Master Output:

Level:.....(-)Infinity to (+)6dB

Detector Loop:

Maximum Input Level:.....(+20dBm
Input Impedance:.....20K ohm
Maximum Output Level:.....(+21dBm
Output Impedance:.....100 ohms

Gate Key Input:

Maximum Input Level:.....20dBm
Input Impedance:.....1K ohm

Applied Research & Technology, Inc
215 Tremont Street
Rochester, New York 14608 USA
Telephone: (716) 436 2720
Fax: (716) 436 3942
Telex: 494973 ARTROC

Applied Research & Technology, Inc. retains a policy of constant product improvement.
Specifications are subject to change without notice.

Designed and Manufactured in the United States of America.

520-5004-100

APPLICATIONS

DUCKING/VOICE-OVER

During a multitrack mixdown you may need to reduce the level of different instruments when the lead vocal needs to dominate. You can accomplish this by using the Detector Loop. With the MDC-2001, you can reduce up to two tracks at a time.

Set-Up

Connect the audio tracks you wish to reduce in level to the inputs of the MDC-2001. Push the Detector Loop switch in. The outputs will be returned to the mix. Patch the lead vocal into the Detector Loop Input. Adjust the Compressor input control to set the compressor threshold level. Set the ratio control to 40:1. Now, when the vocal exceeds the threshold level by 6dB, the audio tracks will be reduced in level by 6dB.

A live DJ situation would be playing the canned mix and wanting to talk over it reducing the mix and letting your voice be intelligible. To do this you would set up the MDC as above.

USE OF AN OUTBOARD EQUALIZER

Applying Equalization to the Noise Gate

An Outboard equalizer can be used to limit the bandwidth of a signal for improving Gate performance. The equalizer is used to set up a certain frequency range which will be used to trigger the gate.

Hook-Up

Patch the equalizer between the Detector Loop Output and the Gate Key Input. Be sure to use stereo cables for proper connection. Left detector output is the tip, right detector output is the ring. These are connected to the equalizer input(s). Left gate key input is tip, right gate key input is ring. These are connected to the equalizer input(s).

Set-Up

After the proper connections have been made, set the EQ curve to eliminate the unwanted frequencies. By just using the significant frequencies to trigger the gate, the gate will close quicker and be less susceptible to interference.

KICK DRUM

Roll off high frequencies that may be bleeding in from other drums and cymbals. Boost frequencies that correspond with the attack and resonance of the kick drum.

VOCAL

Roll off the lower and upper harmonic frequencies. Most vocals fall between 300 Hz and 3.5 KHz. Intelligibility of speech centers around 1.8 to 2.5 KHz.

EXTERNAL DE-ESSING

Use of an outboard equalizer can be used to reduce sibilance in a vocal track. The equalizer is set up to decrease the level of "s" sounds when large amounts of compression is used.

Hook-Up

Patch the equalizer into the Detector Loop. Be sure to use stereo cables for proper connection. Left detector output is the tip, right detector output is the ring. These are connected to the equalizer input(s). Left detector input is tip, right detector input is ring. These are connected to the equalizer input(s).

Set-Up

After the proper connections have been made, set the EQ curve to boost the frequencies between 2KHz and 8KHz. Since boosting levels in the detector loop decreases the threshold of compression, sibilance sounds will be attenuated to lower levels than the remaining program material.

APPENDIX A

DIAGRAMS

GRAPHS

Figure 1 shows compressor input level versus output level for various thresholds. The slope remained constant at a 40:1 ratio.

Figure 2 shows compressor input level versus output level for various slopes. The threshold remained constant at (-)15dB.

Figure 3 shows the input versus output levels of the compressor and limiter set at (0) and (+)10dB with a slope of 40:1.

Figure 4 shows different slope ratios for input level vs output level of the expander. The threshold is set at (+)10dB.

CIRCUIT BLOCK DIAGRAM

Figure 5 is a block diagram showing signal flow and control positions.

PANELS

Figure 6 shows the front panel controls and LED's.

Figure 7 shows the jack locations on the rear panel.

DEFINITION OF TERMS

Attack Time

The time it takes a compressor, limiter or expander to react to changes in signal level.

Compressor

A device that decreases its gain when the input signal level increases therefore reducing the dynamic range of the program material.

De-Esser

A device used to eliminate sibilance from heavily compressed program material.

Detector

A type of circuit which converts an audio signal into a DC control voltage.

Exciter

A device used to bring out certain frequencies in program material.

Expander

A device used to make louder passages louder and quieter passages quieter therefore increasing the dynamic range of the program material.

Hold Time

The amount of time the noise gate is held open after the signal passes threshold.

Noise Gate

A device that turns off an audio signal when its level falls below a threshold level.

Peak Limiter

A device used to prevent instantaneous signal levels from exceeding a set level.

Release Time

The time it takes a compressor, limiter or expander to recover from changes in signal level.

Slope

The rate of attenuation in a compressor or expander.

Threshold

The level where a compressor, limiter, expander or noise gate starts to act on the signal.

VCA

A type of audio amplifier whose gain or attenuation is controlled by an external DC voltage.

MDC-2001 COMPRESSOR

IN vs. OUT @ VARIOUS THRESHOLDS

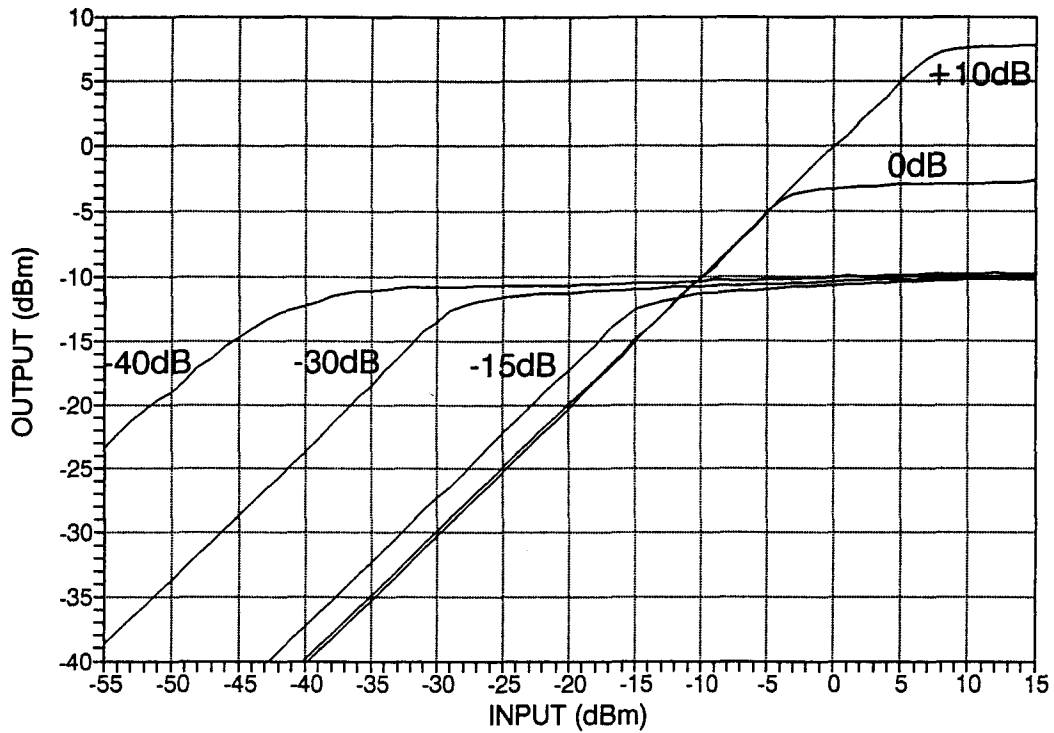

Figure 1

MDC-2001 COMPRESSOR

VARIOUS SLOPES @ SAME THRESHOLD

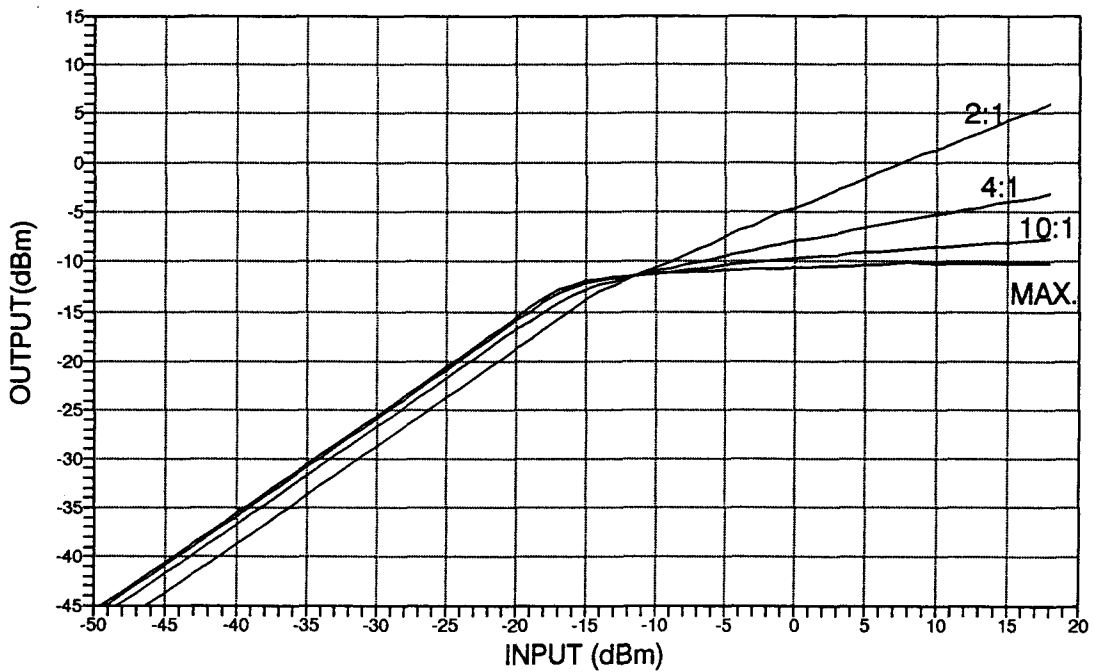

Figure 2

MDC-2001 COMPRESSOR/LIMITER CURVES

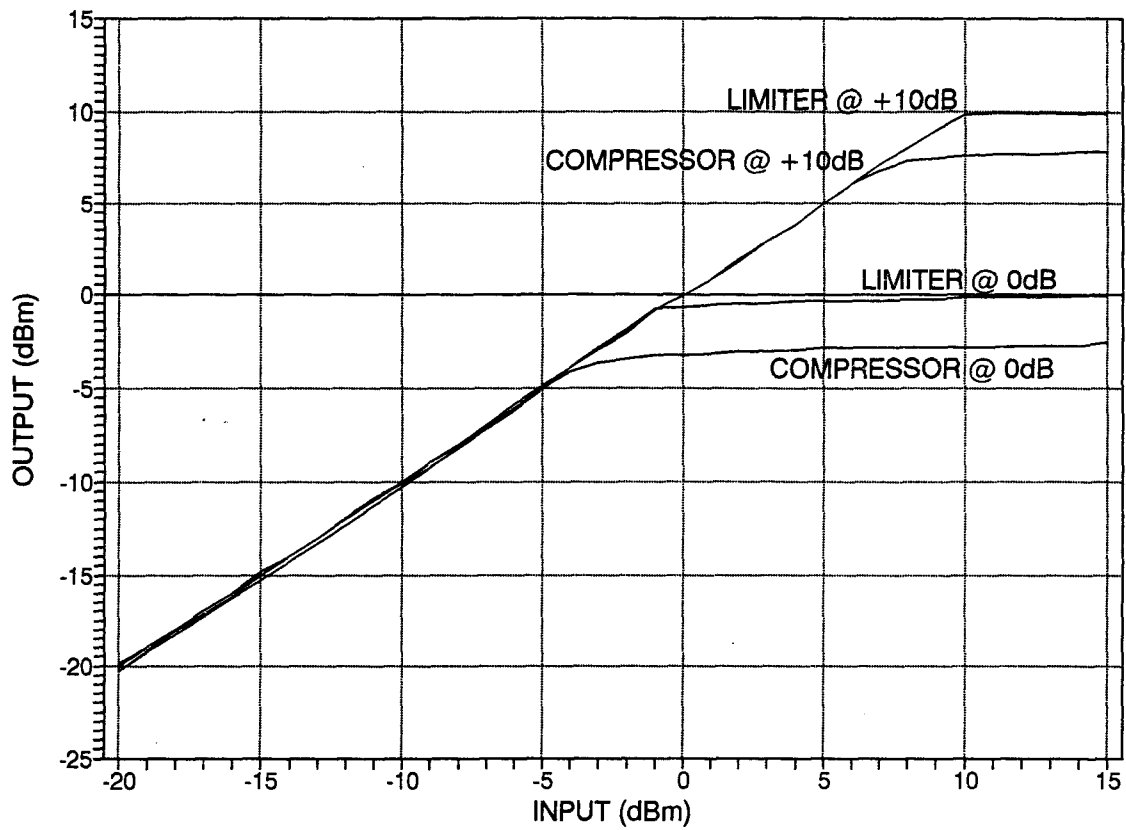

Figure 3

MDC-2001 EXPANDER VARIOUS SLOPES @ SAME THRESHOLD

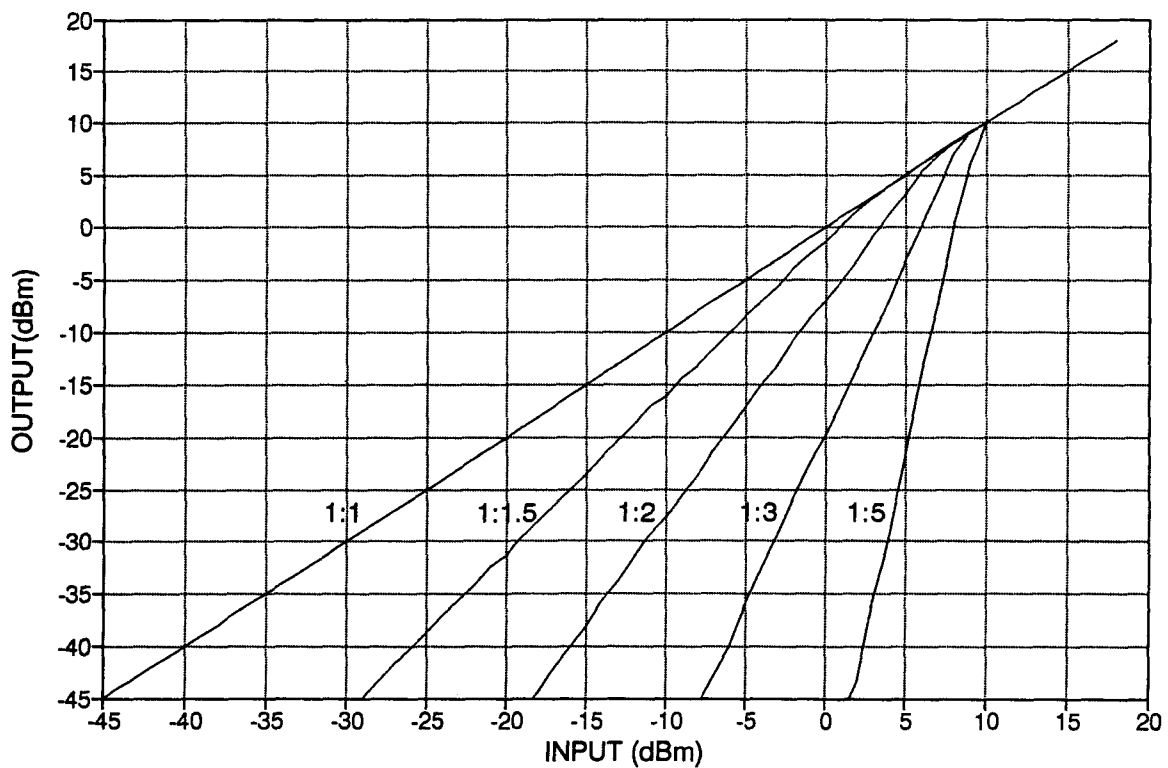

Figure 4

MDC BLOCK DIAGRAM
(EACH CHANNEL)

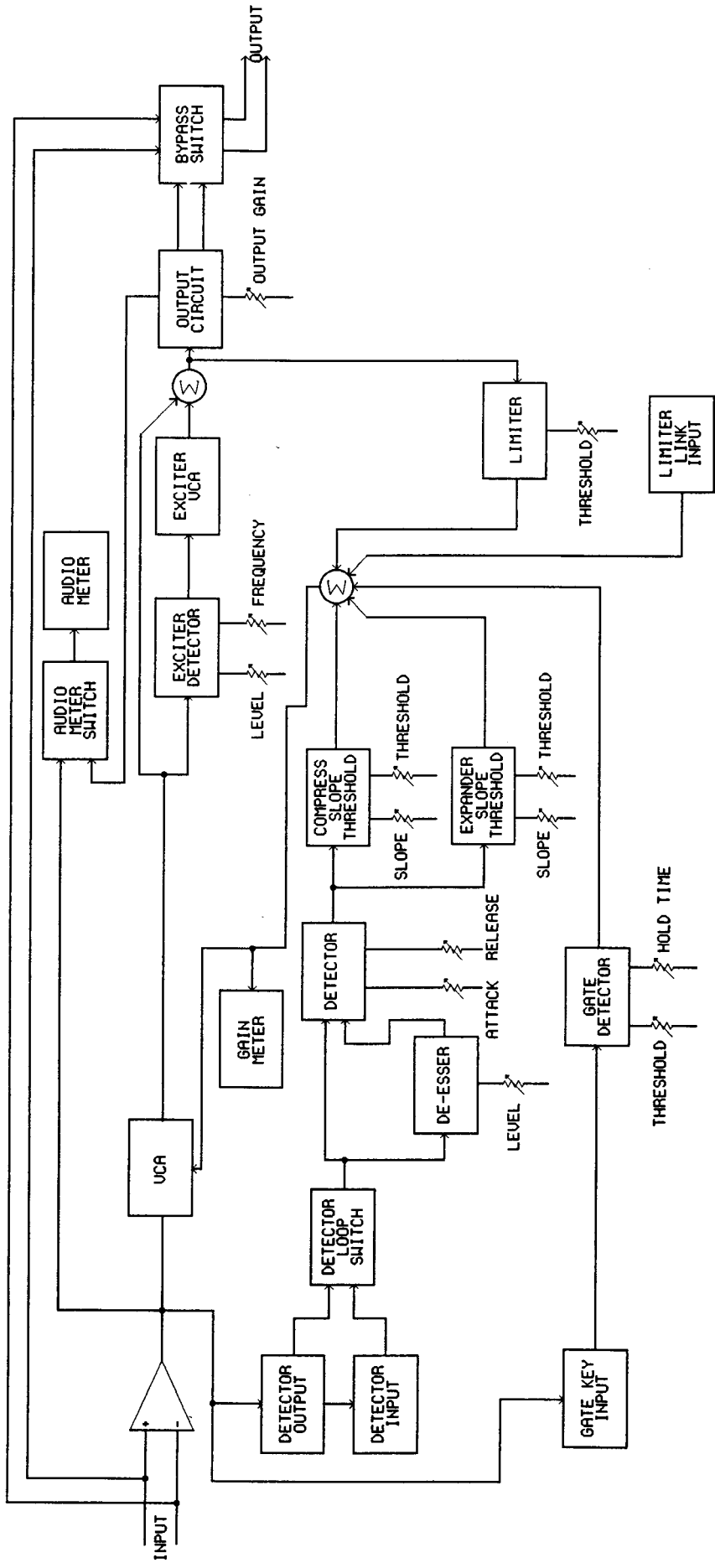

Figure 5

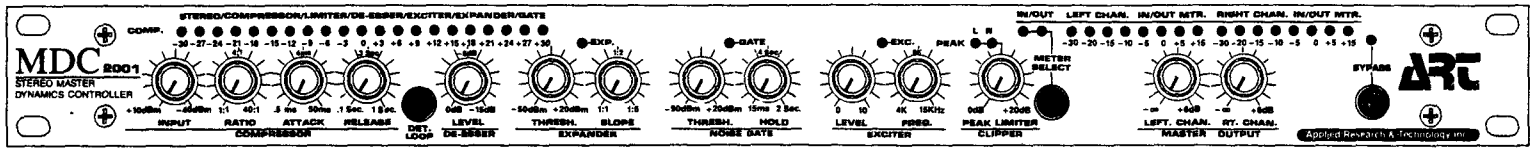

Figure 6

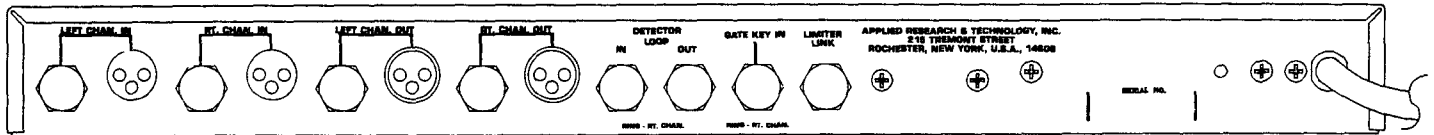

Figure 7

WARRANTY & SERVICE INFORMATION

Warranty service for this unit will be provided by Applied Research & Technology, Inc. in accordance with the following warrant statement.

Applied Research & Technology, Inc. warrants to the original purchaser that this product and the components thereof, will be free from defects in workmanship and materials for a period of one year from the date of purchase. Applied Research & Technology, Inc. (ART) will, without charge, repair or replace, at its option, defective product or component parts upon prepaid delivery to the factory service department or their authorized service center, accompanied by proof of purchase date in the form of a valid sales receipt.

EXCLUSIONS:

This warranty does not apply in the event of misuse or abuse of the product or as a result of unauthorized alterations or repairs. This warranty is void if the serial number is altered, defaced, or removed.

ART shall not be liable for any consequential damages, including without limitation damages resulting from loss of use. Some states do not allow limitation of incidental or consequential damages, so the above limitation or exclusion may not apply to you.

This warranty gives you specific rights and you may also have other rights which vary from state to state.

For units purchased outside The United States, service will be provided by an authorized distributor of Applied Research & Technology, Inc.

The following information is provided for the unlikely event your unit requires service and must be returned to the factory.

- 1) Be sure the unit is the cause of the problem. Check to make sure the unit has power supplied, all cables are connected correctly and the cables themselves are in working condition.
- 2) If you find the unit to be at fault, write down a description of the problem including how and when the problem occurs.
- 3) Call the factory for a Return Authorization (RA) number.
- 4) Pack the unit in it's original carton or a reasonable substitute. The packing box is not recommended for a shipping carton. Put the packaged unit in another box for shipping. **Print the RA number clearly under the address. NOTE:** The front panel is subject to damage if the unit is poorly packaged.
- 5) Include with your unit: a return shipping address (We cannot ship to a P.O. box) a copy of your purchase receipt, a daytime phone number, and the description of the problem.
- 6) Ship the unit to:

APPLIED RESEARCH & TECHNOLOGY, INC.
215 TREMONT STREET
ROCHESTER, NY 14608
ATTN: REPAIR DEPARTMENT
RA # _____

OUR NEW AREA CODE IS 585

- 7) Contact our customer service department at (716) 436-2720 for your Return Authorization number or if you have any questions regarding repairs.