

# MX524

FIVE CHANNEL FOUR ZONE MIC/LINE MIXER

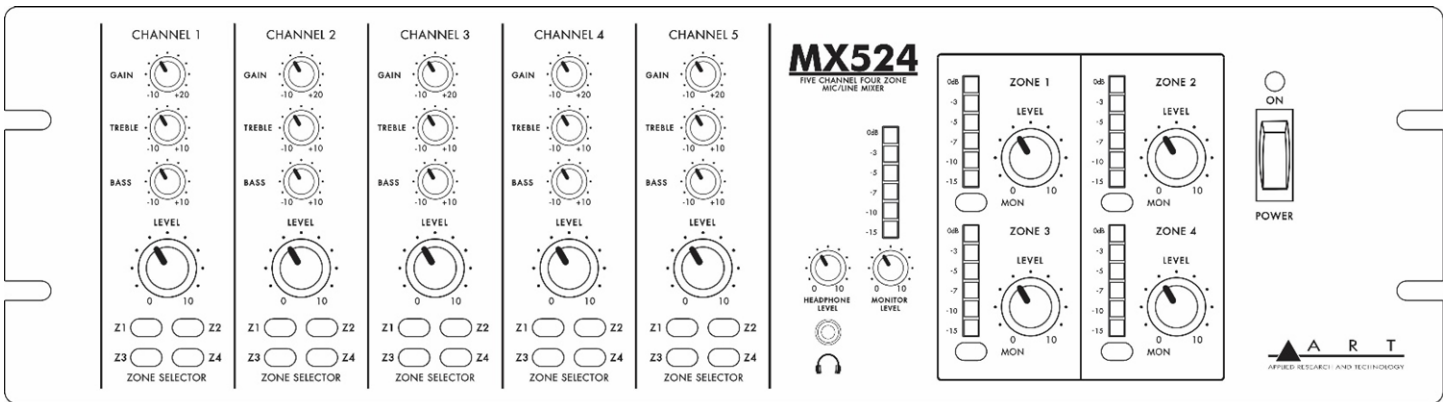

# USER'S MANUAL



# IMPORTANT SAFETY INSTRUCTIONS - READ FIRST



This symbol, wherever it appears, alerts you to the presence of uninsulated dangerous voltages inside the enclosure that may be sufficient to constitute a risk of shock



this symbol, wherever it appears, alerts you to important operating and maintenance instructions in the accompanying literature. Please read the manual.

**Read instructions** Retain these safety and operating instructions for future reference. Heed all warnings printed here and on the equipment. Follow the operating instructions printed in this user guide.

**Do not open** There are no user serviceable parts inside. Refer any service work to qualified technical personnel only.

**Power sources** Only connect the unit to mains power of the type described in this user guide or marked on the rear panel. The power source must provide a good ground connection.

**Power cord** Use the power cord with sealed mains plug appropriate for your local main supply as provided with the equipment. If the provided plug does not fit into your outlet consult your service agent. Route the power cord so that it is not likely to be walked on, stretched or pinched by items placed upon or against.

**Grounding** Do not defeat the grounding and polarization means of the power cord plug. Do not remove or tamper with the ground connection on the power cord.

**Moisture** To reduce the risk of fire or electrical shock, do not expose the unit to rain, moisture or use in damp or wet conditions. Do not place containers of liquid on it, which may spill into any openings

**Heat** Do not locate the unit in a place close to excessive heat or direct sunlight, as this could be a fire hazard. Locate the unit away from any equipment which produces heat, such as power supplies, power amplifiers and heaters.

**Environment** Protect from excessive dirt, dust, heat, and vibration when operating and storing. Avoid tobacco ash, drink spillage and smoke, especially that associated with smoke machines.

**Handling** Protect the controls from damage during transit. Use adequate padding if you need to ship the unit. To avoid injury to yourself or damage to the equipment, take care when lifting, moving or carrying the unit.

**Servicing** Switch off the equipment and unplug the power cord immediately if it is exposed to moisture, spilled liquid or the power cord or plug becomes damaged during a lightning storm or if smoke odor or noise is noted. Refer servicing to qualified technical personnel only.

**Installation** Install the unit in accordance with the instructions printed in the user guide.

# INTRODUCTION

The **ART MX524 Five Channel Four Zone Mic/Line Mixer** is a versatile rack mount mixer that combines Five independent input channels and routes them to four zone outputs. Channels one thru four accept a balanced Line or Mic signal thru the Combo jack connector. CH5 accepts a line level signal through RCA jacks. The unit has an independent selectable +48 Volt phantom power function for channels one thru four. Channels one thru four can also accept unbalanced line-level signals. Each channel has a level control and can be routed to any zone output. Separate level, bass and treble controls adjust the sound of each input channel.

The ART MX524 may be used on stage, in the studio, or for permanent install applications including conference rooms, corporate boardrooms, churches, restaurants, small clubs, health clubs and more. A built-in power supply and triple high 19-inch rack mount format allows for easy installation and reliable long-term operation.

## Features

- Five input channels with individual level controls using XLR/Phono jacks with master level, bass and treble controls
- CH1 Mic/Line Input (factory set) automatically ducks CH2 - CH5 outputs
- Balanced Mic/Line XLR inputs for channels one thru four
- Full +48V low-noise phantom power for channels one thru four mic inputs
- Front panel 1/8-inch stereo (TRS) mini-phone plug for Headphone monitoring
- Four sets of Euro Bloc connectors for the Zone outputs
- Telephone paging function
- Dc power back up
- Separate monitor outputs
- LED VU meter on all outputs
- Rear mount RCA Line inputs for additional audio inputs
- Rugged 3U rack-mount steel chassis with built-in power supply
- Perfect for stage, studio and permanent installations
- Three-year warranty

## Unit Initial Setup

Before any audio connections are made, please review if the CH1 Mic/Line is needed as a main talk over feature is for your application. The unit is factory setup for this feature. If you would prefer to use Channels 1 thru 5 as just audio inputs then an internal jumper will need to be moved to disable the feature. Please see the section labeled on page 11, "Dedicated CH1 Mic/Line Ducking and Rear Priority Switch Function" to make this change.

# OPERATION

## Front Panel Controls

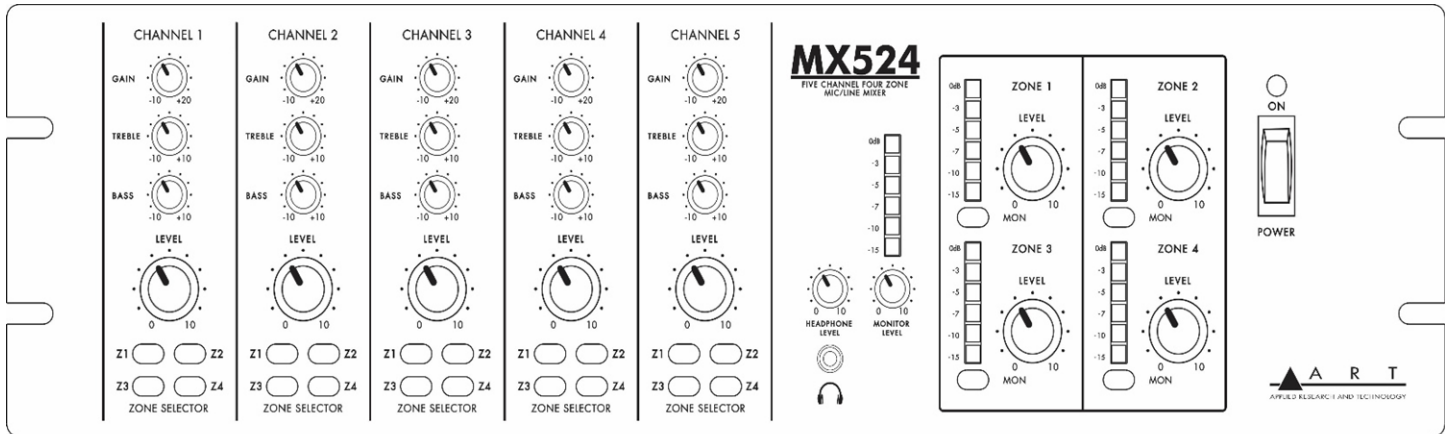

### 1. Gain pot

The pot optimizes the input level for this channel. Turning the pot clockwise increases the input level.

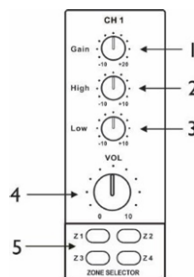

### 2. High pot

This is the Treble control. You can get minimize high frequency noise or boost the sound of cymbals or high frequency harmonics. The gain can be varied from -10dB to +10dB with the center frequency at 10kHz.

### 3. Low pot

This is the Bass control. You can Boost as an example vocal, kickdrums or guitar. The gain can be varied from -10dB to +10dB with the center frequency at 100Hz.

#### 4. Volume pot

The pot controls the individual channels volume levels.

#### 5. Zone selector

Zone's 1-4 can be assigned when these switches are engaged. Engage the button Z1 and the signal is assigned to ZONE1. Release the button to disengage the signal from ZONE1. Zones 2-4 can be assigned the same way.

#### 6. Phone volume

The pot controls the monitor level of the Headphone jack.

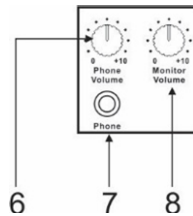

#### 7. Phone

The monitor signal of the mixer can be sent to a pair of headphones.

#### 8. Monitor Volume

This pot controls the output level to the monitor outputs on the rear panel.

#### 9. Zone 1 Volume

The pot controls the volume level of ZONE1.

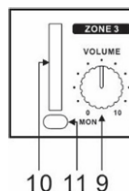

#### 10. LED VU-meter

This is the 6-segment stereo LED-meter that indicates the level of the overall signal.

#### 11. MONITOR selector

Engaging the MONITOR switch, allows you to listen to any selected of zone outputs. If multiple switches are selected the monitor output is a summation of all of them.

## 12. Power

The LED is the power indicator. When the MX524 is powered on, this RED LED will light up. When the MX524 is powered down the RED LED light will go off.

## 13. Power switch

When the switch is set to the ON position, the MX524 is powered on. When the switch is set to the OFF position the MX524 is powered down.

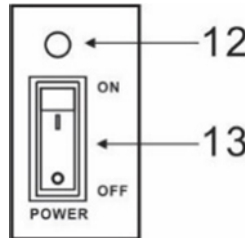

## Rear Panel Connections

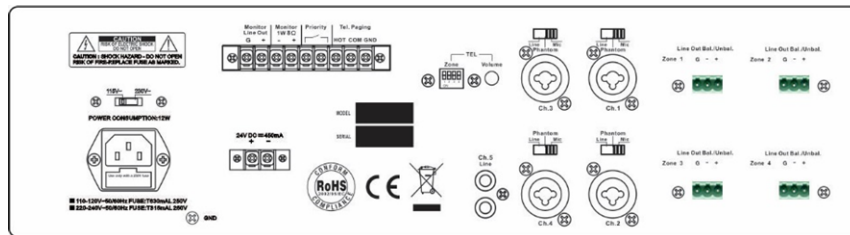

## 14. AC Input

This is the power inlet connector jack. This connects the unit to the main power source.

## 15. AC fuse

The fuse protects the unit from current surges and over voltages issues. The fuse should only be replaced with the same size and style.

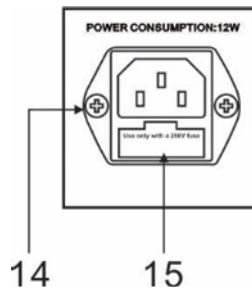

## 16. AC Voltage Selector

When the AC voltage selector is set to the left 115V, the unit accepts AC input voltages from 100V to 127VAC. When the AC voltage selector is set to the right 230V, the unit requires an AC input voltage between 220V to 240V.

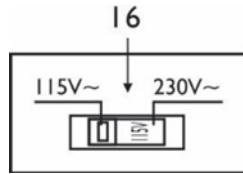

## 17. Monitor Line Out

The Monitor Line Out terminals (Barrier strip) can be connected to other equipment, such as an amplifier or recording devices.

## 18. Monitor Low Z Output

The terminal is meant for the connection of a small external loudspeaker that is driven by an internal auxiliary power amplifier, providing a nominal output 1 Watt.

Only the mixed audio signal coming from the “AUX IN” are included in the output signal.

In addition, the output signal is controlled only by the volume control of “CH4”, “CH5”, audio signal level control.

## 19. “Priority” Terminal

When these terminals are shorted (i.e., by means of using an electrical switch), the audio signals coming from “CH2” thru “CH5” inputs are attenuated, while the audio signal coming from “CH1, is set as the priority. This terminal is not functional if the internal jumper has be adjusted to defeat the CH1 ducking feature.

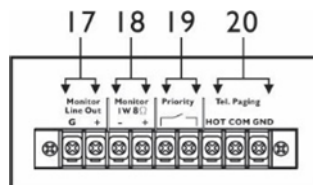

## 20. Input “Tel Paging”

The connection of these terminals will allow you to connect to an auxiliary telephone signal. The input features a “Voice Priority” function which overrides all other input signals. This feature allows the signal from the phone input to be present on any the zones that are selected using the dip switches located on the rear of the unit. The signals coming from any of the other input sources will be attenuated if that zone has been selected via the dip switch. This feature works independently from the rear priority and CH1 ducking features.

## 21. Tel. Input

### a Zone

This function will duck the signals present on zones 1 through 4 when the dip switch is engaged for each zone. Set the switch to the low position to enable sending this phone signal to the corresponding Zone output.

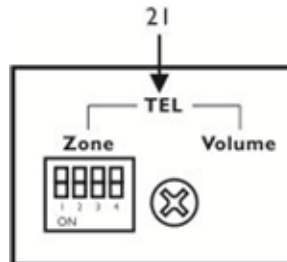

### b Volume

When the DIP switches are engaged, it then controls the volume of the sound source, that is connected to the "Tel Paging" barrier terminals. Turning the pot clockwise increases the volume of the corresponding source. Keep this control at its' minimum setting when this function is not used.

## 22. "Line IN" inputs

An audio source with a high-level output signal, such as a Tuner, CD Player or any Digital audio source. There is an input sensitivity switch to adjust for suitable for a variety of audio sources. This is an RCA-type coaxial connector, for an unbalanced audio source.

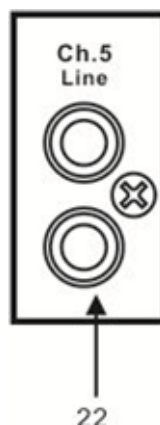



### 23. The Mono MIC/LINE channels

You can connect balanced line level or MIC level sources to these combo jacks. On the ¼-inch phone jack you can connect either a microphone or a line level instrument. You cannot connect an unbalanced microphone to the XLR jack, as it will damage both the microphone and the mixer.

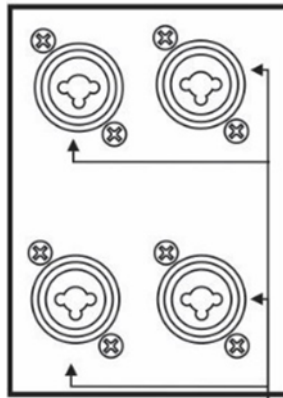

23

### 24. CH1 Thru CH4 inputs sensitivity and XLR phantom switch

Sliding the switch to the “LINE” position, CH1 thru CH4 inputs can be connected to an audio source with high level signal. Sliding these switches to the MIC position, CH1 thru CH4 inputs can be connected to a dynamic microphone with a low impedance. By sliding the switch to “Phantom” position, this connects the phantom supply to the XLR of Pins 2 and 3 of CH1 thru CH4, this is necessary to operate the condenser microphones which require this type of external supply. It is recommended to use this switch with the general volume set to minimum.

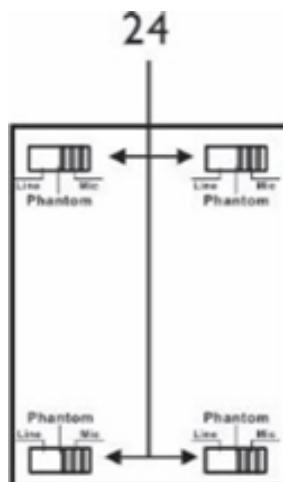

24

## 25. Line Out Bal/Unbal

These terminals can be connected to other equipment, such as an amplifier or recording equipment.

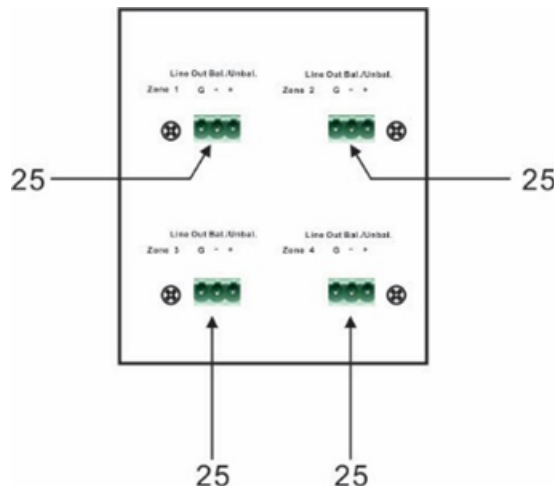

## 26. DC Power Supply

The MX524 mixer can operate using a 24Vdc power supply. When both the AC and DC source are connected, the MX524 runs off the AC power source. The DC supply is used when the AC source fails.

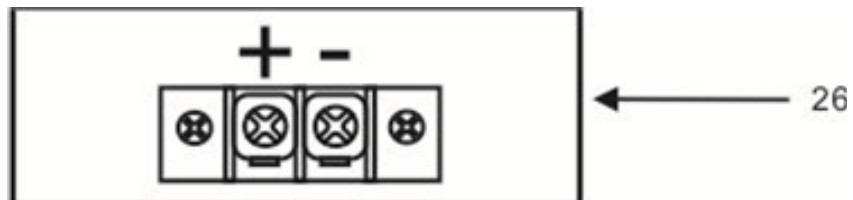

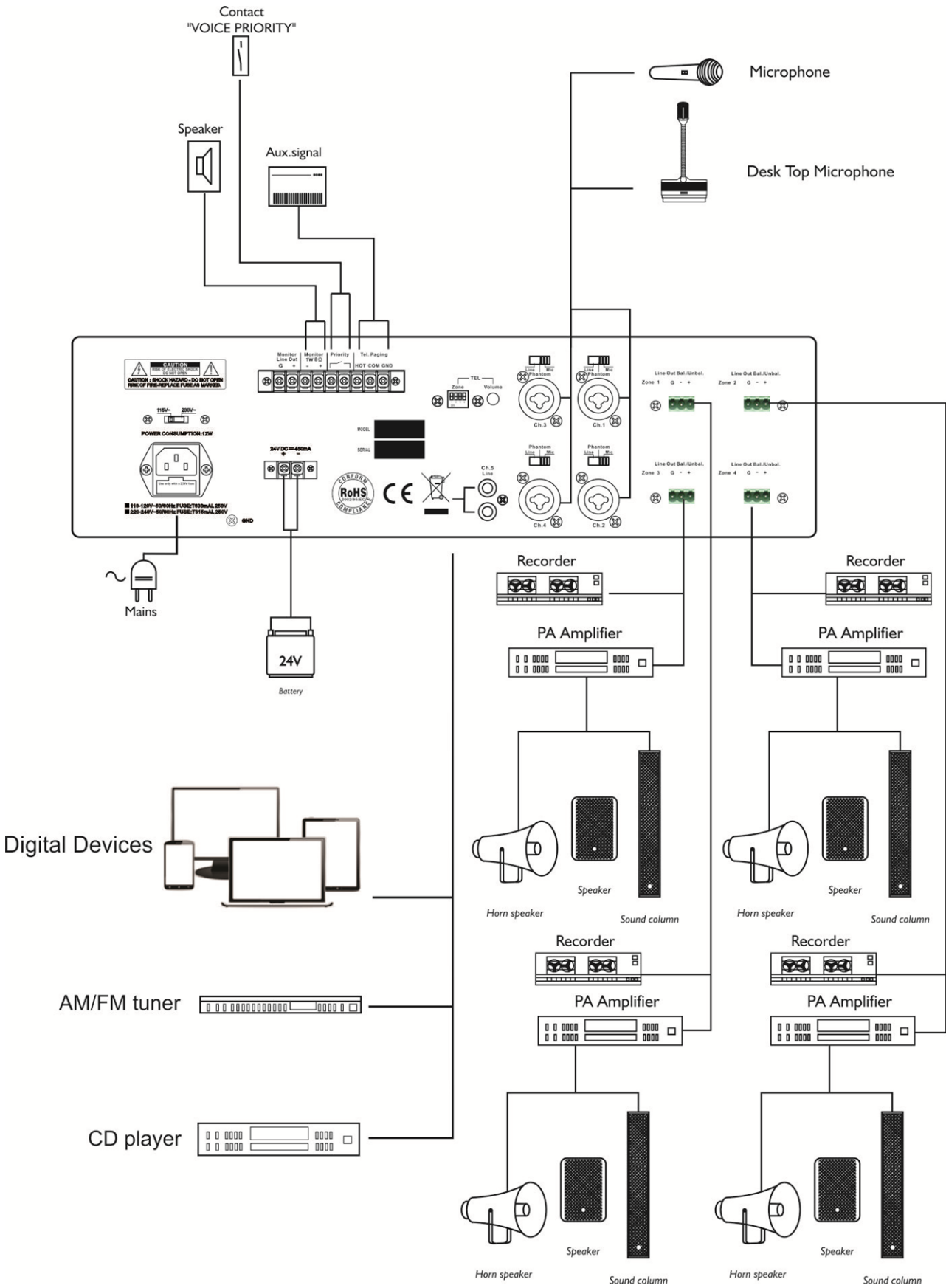

## Dedicated CH1 Mic/Line Ducking and Rear Priority Switch Function

The Ch1 Mic/Line Input is setup (factory default) as a dedicated talk over feature. The ducking function for the CH1 Mic/line input can be deactivated by moving an internal jumper located on the rear ckt board in the unit. Moving this jumper disables the CH1 ducking feature and the rear priority feature. The chassis cover will need to be removed in order to change the setting. Please see the diagram below to set the jumper in the appropriate position.

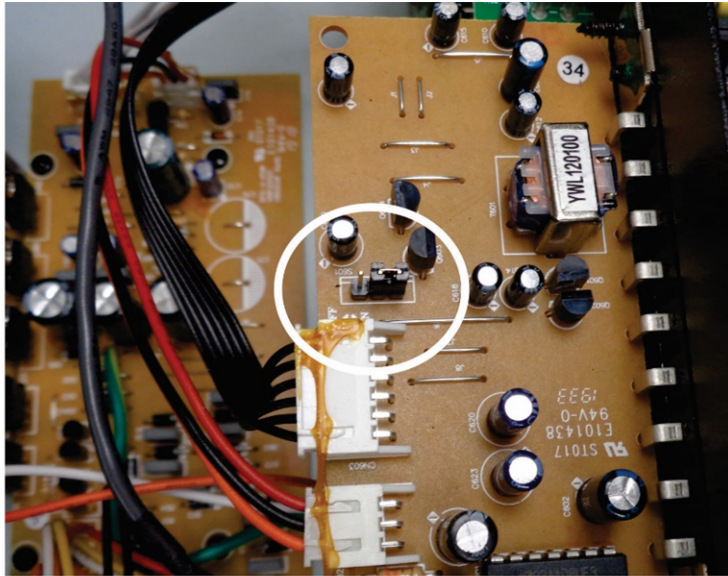

Ch1 Ducking and rear Priority switch are active as shown rear two pins are shorted using the shorting jumper.

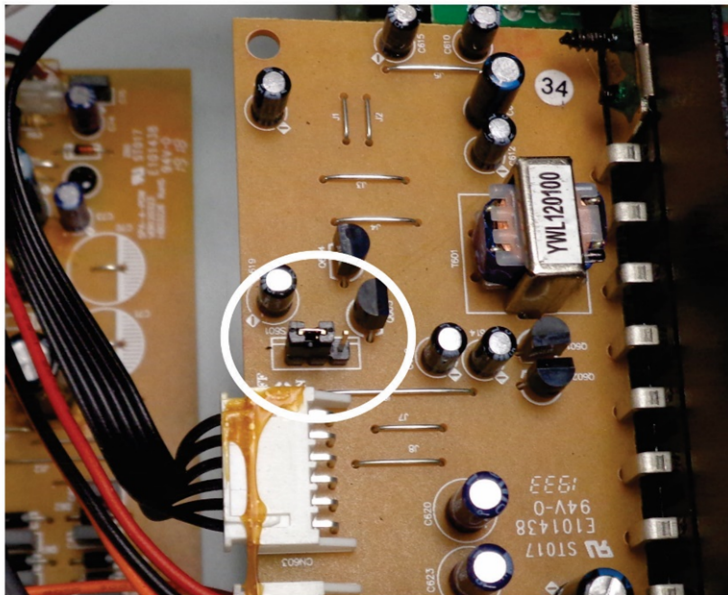

Ch1 Ducking and rear Priority switch are defeated as shown first two pins are shorted using the shorting jumper.

## **WARRANTY INFORMATION**

### **Limited Warranty (USA only)**

Applied Research and Technology will provide warranty and service for this unit in accordance with the following warrants:

Applied Research and Technology, (ART) warrants to the original purchaser that this product and the components thereof will be free from defects in workmanship and materials for a period of **three** years from the date of purchase. Applied Research and Technology will, without charge, repair or replace, at its option, defective product or component parts upon prepaid delivery to the factory service department or authorized service center, accompanied by proof of purchase date in the form of a valid sales receipt.

### **Exclusions**

This warranty does not apply in the event of misuse or abuse of the product or as a result of unauthorized alterations or repairs. This warranty is void if the serial number is altered, defaced, or removed.

A R T reserves the right to make changes in design or make additions to or improvements upon this product without any obligation to install the same on products previously manufactured.

A R T shall not be liable for any consequential damages, including without limitation damages resulting from loss of use. Some states do not allow limitations of incidental or consequential damages, so the above limitation or exclusion may not apply to you. This warranty gives you specific rights and you may have other rights, which vary from state to state.

For units purchased outside the United States, an authorized distributor of Applied Research and Technology will provide service.

## SERVICE

The following information is provided in the unlikely event that your unit requires service.

1. Be sure that the unit is the cause of the problem. Check to make sure the unit has power, all cables are connected correctly, and the cables themselves are in working condition. You may want to consult with your dealer for assistance in troubleshooting or testing your particular configuration.
2. If you believe that the ART unit is at fault, go to [www.artproaudio.com](http://www.artproaudio.com).
3. Select “*Support*”, then “*Return Authorization Request*” to request a return authorization number.
4. If you are returning the unit for service, pack the unit in its original carton or a reasonable substitute. The original packaging may not be suitable as a shipping carton, so consider putting the packaged unit in another box for shipping. Print the RA number clearly on the outside of the shipping box. Print your return shipping address on the outside of the box.
5. Include, with your unit, a note with the RA number and your contact information, including a return shipping address (we cannot ship to a P.O. box) and a daytime phone number, and a description of the problem, preferably attached to the top of the unit. Also include a copy of your purchase receipt.

Please fill in the following information for your reference:

Date of purchase: \_\_\_\_\_

Purchased from: \_\_\_\_\_

Serial Number: \_\_\_\_\_

# SPECIFICATIONS

<b>Frequency Response</b>	20 Hz – 22kHz $\pm$ 2 dBu
<b>Max. Input Gain</b>	60dB CH MIC. Input Main out (XLR, balanced) 50dB CH MIC. Input & REC. out (unbalanced) 60dB CH MIC. Input Mic. out (unbalanced) 60dB CH MIC. Input Mono out (unbalanced)
<b>THD&amp;N</b>	<0.03% @1kHz
<b>Impedance</b>	Microphone input: 1.4k $\Omega$ All other inputs 10k $\Omega$ or greater Zone outputs 120 $\Omega$ Monitor Speaker output 8 $\Omega$ Monitor Line output 120 $\Omega$
<b>Phantom power</b>	48VDC
<b>EQ</b>	Low: $\pm$ 10 dB - 100 Hz High: $\pm$ 10 dB - 10 kHz
<b>Zone Outputs</b>	+26dB (Balanced)
<b>Monitor Line Output</b>	+15dB (Unbalanced)
<b>Monitor speaker output</b>	1 W rms / 8 $\Omega$
<b>Headphone output</b>	0.5 W rms / 47 $\Omega$
<b>Connectors</b>	Inputs: Combo XLR/ $\frac{1}{4}$ Jacks, RCA Outputs: Euroblock, Screw terminals

<b>Power Requirements USA</b>	110~120VAC 50/60Hz or 24VDC Export units configured for country of destination
-------------------------------	-----------------------------------------------------------------------------------

<b>Dimensions (HWD)</b>	5.1-inch x 19-inch x 7.5-inch 130mm x 483mm x 191mm
-------------------------	--------------------------------------------------------

<b>Weight</b>	6.63 lbs. (3.0 kg)
---------------	--------------------

Note: 0 dBu = 0.775Vrms

ART maintains a policy of constant product improvement. Therefore, specifications are subject to change without notice.



**[www.artproaudio.com](http://www.artproaudio.com)**  
**E-mail: [support@artproaudio.com](mailto:support@artproaudio.com)**

© 2021 Applied Research & Technology

**MX524**  
FIVE CHANNEL FOUR ZONE MIC/LINE MIXER

**524-5004-102**