

SGX
2000
EXPRESS

SGX
NIGHTBASS
STUDIO EDITION

SGX
NITRO

MULTIVERB
ALPHA
STUDIO EDITION

DR-X
2100
STUDIO EDITION

ATTACK
MODULE K



THE PHANTOM

ART

DESIGNED AND MANUFACTURED IN THE USA

PHANTOM SERIES CONSOLE
OPERATION GUIDE

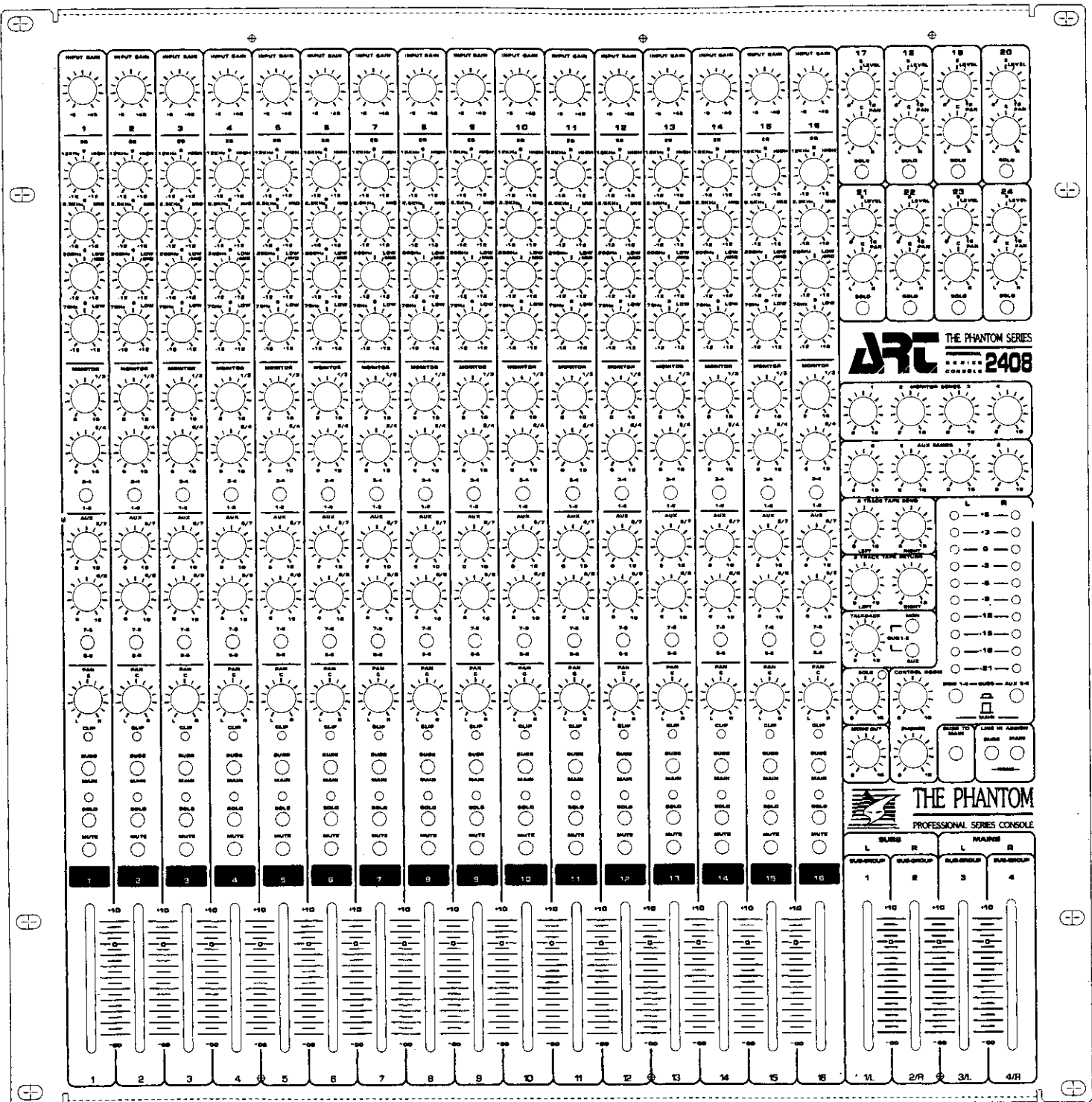
USER'S GUIDE



PHANTOM SERIES CONSOLE
OPERATION GUIDE

APPLIED RESEARCH & TECHNOLOGY, INC.
 575 TREMONT STREET
 ROCHESTER, NY USA 14608

WARNING: SHOCK HAZARD - DO NOT OPEN
AVIS: RISQUE DE CHOC ELECTRIQUE - NE PAS OUVRI

MODEL 602 SERIAL NO. _____

THE PHANTOM
 PROFESSIONAL SERIES CONSOLES

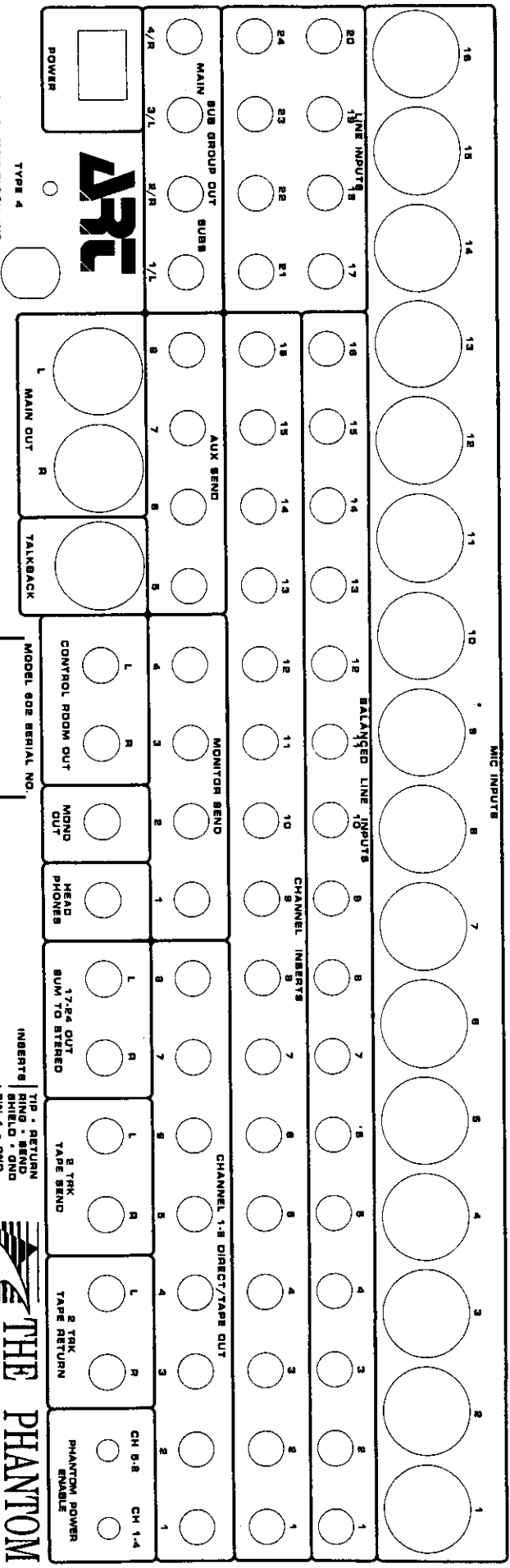

ART

TYPE 4

CONTROL ROOM OUT

TALKBACK

MONITOR SEND

MIND OUT

HEAD PHONES

17-24 OUT

BUM TO STEREO

CHANNEL 1-8 DIRECT/TAPE OUT

TAPES SEND

TAPES RETURN

CH 5-8

CH 1-4

PHANTOM POWER

INSERTS

TIP RETURN

SHIELD

PIN 1 - GND

PIN 2 - . . .

PIN 3 - . . .

XLR'S

INTRODUCTION

Thank you and congratulations on your new ART purchase. The Phantom Series Console you have just purchased offers the performance and features of recording consoles costing thousands of dollars more. We designed the Phantom Series to take the pounding life on the road and be right at home in a recording studio. Using years of applied audio technology, the Phantom Series was designed to be your first choice in recording technology. Whether you bought the sixteen, twenty-four, or thirty-two channel, your choice is a world class professional console.

The ART of mixer design:

For the ART Phantom series of mixers we set about to design a family of mixers that would be flexible enough to be able to cover a wide range of applications and offer a true value with far better performance and functionality than anything else in their price range. By applying our CAD expertise, rigorous CAE analysis, automated test techniques, design for manufacturability programs, and our knowledge, gained over years of designing highly complex analog circuitry for the professional audio industry, we were not only able to meet the goals we set out for our mixers but, also to improve upon some of the critical performance areas of conventional mixer design.

We chose the latest in automated assembly potentiometers that, if compared to one of our competitors, are fourth generation, ultra precision totally sealed controls. We use high precision auto-insertable parts in all key circuitry areas and minimal harness wiring for low noise, high reliability, and consistent signal integrity. An all steel chassis provides exceptional hum and R.F. shielding, and the built in over designed power supply has its own shielded compartment. In addition, if due to an accident or abuse, you have a problem, simply removing about a dozen screws gives you total access, making the Phantom series one of the quickest and easiest mixers to service in the field at any price!

There are two areas in any mixer that determine 90% of its audio performance. In the first area,

the mic input preamp, we use a special 6 transistor op-amp hybrid design that yields extremely low noise, high CMRR, excellent headroom, and exceptional transient response (can handle a whisper to a shotgun blast.) The second area, the mix amp, also uses a hybrid circuit design that not only yields superior noise performance, when one channel is assigned, but also has very low noise when all channels are assigned to the buss, a more common occurrence. The Phantom's mix amps have extended headroom, that equals other high end recording desks. This attention to noise performance and headroom is found only on the most expensive consoles.

All primary channels have balanced XLR inputs. Studio quality phantom powering is available via rear panel switches. Our flexible 4 band EQ section has excellent dynamic range and the controls feature progressive tapering so that whenever the controls are at 12 o'clock you can be sure of flat response. In fact the Phantom series of mixers offers a frequency response that is within +/-0.5dB at 20kHz, far better than most conventional mixers and more in line with the emerging requirements of digital recording and mastering.

There are many other features and functions in the Phantom series that address a wide variety of applications, such as, full solo and talkback facilities, individual channel muting, 2-track ins and outs, separate control room and headphone outputs, switchable metering, 4 monitor and 4 aux sends that can be internally configured as pre

or post fader depending on application, line ins on all channels, channel inserts on all primary channels, 8 direct outs, mono out, and much more. The real power of this family of mixers, however, lies in its signal routing flexibility. In the case of the 2408 you can configure it from a 16 X 8 X 2 mixer to a 27 X 2 mixer and just about any combination in between. There are 213 pots, 89 jacks, and 95 switches on the 2408 giving you a maximum of flexibility with a minimum of repatching.

For P.A. use, the Phantom's mic inputs on each primary channel, balanced XLR main outputs, mono output, 4 sub-group capability, up to 8 monitor mixes, independent 8 into 2 mix section, assignable talkback, and the ability to solo muted channels, meet the requirements of live mixing on all but the largest jobs. Whether used as the main board, monitor board, or as both in a club, the Phantom series is configurable to accommodate virtually any venue.

In sound contract or fixed installation, the multiple outputs are extremely useful. For

FEATURES:

- * 16, 24, or 32 Channel (model 1608, 2408, 3208)
- * Balanced XLR Mic inputs
- * Independent Configurable 8X2 Mixer
- * Four Main Buses can be Run Independent or Summed Stereo
- * Summed Mono Output of the Two Stereo Buses
- * Parallel Mode Discrete Low Noise Mic Amps
- * Discrete Low Noise Mix Amps
- * Line inputs
- * Eight Pre/Post Fader Mix Buses
- * All Monitor/Auxiliary Sends are Internal Jumper Selectable for Pre or Post Fader
- * Eight Direct Outs
- * T.R.S. Inserts on all Mic Inputs
- * More than 20 Mix Outputs
- * 4 Band Low Noise EQ

Record for your reference:

DATE OF PURCHASE _____
 PURCHASED FROM _____
 SERIAL NUMBER _____

example, in a church installation the Phantom can provide a mix output for the house, two remote clusters, an under balcony mix, nursery feed and still have mix outs for recording, all with at-console level controls.

For professional or home recording the Phantom series can easily accommodate an 8-track, 4-track, and 2-track, with plenty of aux sends for effects, an 8 into 2 submix for either drum machines, keyboards, or 8-track cue, while still having most of its primary channels open for mics and instruments. Its performance specifications meet or exceed those of current digital recording practices. The direct channel outputs can allow for multitrack mastering.

The Phantom's shielded steel case, balanced XLR inputs, and multiple output busses, will make it a very cost effective answer in many broadcast and post production facilities.

These are just a few of the applications where the Phantom series of mixers offers true value and flexible growth potential.

- * Eight Phantom Power Inputs
- * Dedicated 8 Channel Tape Return Section
- * LED Clip Indicator for Each Channel
- * Full Channel Soloing and Muting With LED Indicators
- * Switchable Metering
- * Isolated 2-Track Monitor Tape Return
- * Separate Stereo Control Room Output
- * Assignable Talkback/Main/Monitor/Aux
- * Independent Solo Level
- * Separate Headphone Output
- * Sealed Body Low Noise Pots
- * All Steel Chassis
- * Hard Contact Switches
- * Optional Wood End Panels
- * Designed and manufactured in the United States of America

600-5004-100

ABOUT THIS MANUAL...

The manual you are about to read (hopefully!) covers all the Phantom Professional Series Consoles, the 1608, 2408, and 3208. When features differ, we'll tell you with a Note-box what is different between models. Generally, the differences are in numbers only.

INSTALLATION

The PHANTOM SERIES CONSOLES may be used in a variety of setups including: Home and Studio Recording, Live Sound, P.A., Keyboard, Guitar and Drum Racks, and Fixed Installation. Self contained in an all steel case, the PHANTOM SERIES CONSOLE is designed for continuous professional use. Mounting location is not critical, but for greater reliability we recommend that you not place the unit on top of power amps, tube equipment, or other sources of heat.

Of course, the best location for your Phantom Console is in a clean and dry environment. We realize this is not possible for many situations but, there are precautions you can take to protect your console. In a hostile environment (clubs), cover your Phantom when not in use. Buy a road case for transporting your console. When used in a tame environment, protect your console from dust.

You may mount models 1608 and 2408 into a standard 19" rack, you will need 11 rack spaces. Don't forget to leave access space for your outputs! Dimensions are: 19.25"H, 19.0" W, 8.0"D for the 1608 and 2408. Dimensions for the 3208 are: 19.25"H, 28.5"W, and 8.0"D.

CONNECTIONS

POWER

This device is AC powered via a standard 3 conductor grounded power cable. Plug into any standard AC receptacle. We recommend the use of a surge protector to decrease the chance of equipment damage due to voltage surges or spikes on the line. For your own safety as well as the safety of others, do not remove the ground pin of the cable. Do not use a three to two prong adapter either. Refer to the rear panel or the specifications for proper operating voltages.

AUDIO

Audio connections to the Phantom Series Consoles are made at the rear of the unit via professional 1/4" stereo and mono phone jacks and XLR connectors. All XLR connectors follow the A.E.S. standard wiring configuration of Pin 1 Ground, Pin 2 (+) Hot, and Pin 3 (-).

CLEANING

Avoid using harsh abrasives, chemicals or solvents when cleaning the surface of your Phantom Console, use a damp cloth. We do not recommend cleaning or lubricating the faders, pots, or switches with commercial cleaners or lubricants.

CONTACT

Applied Research & Technology
215 Tremont Street
Rochester, New York 14608
United States of America
Telephone: 716-436-2720
Fax: 716-436-3942

TOP PANEL CONTROLS AND FEATURES

INPUT CHANNEL CONTROLS

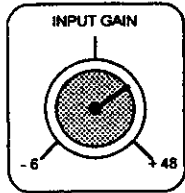

INPUT GAIN

The Input Gain control adjusts the amount of signal level received from the Mic or Line Inputs. Setting this control is critical to the performance of your Phantom Mixer. Using this control wisely allows you to accommodate virtually every signal source applied to the mixer inputs. All microphones, keyboards, instruments, tape and other program source devices have their signal level optimized for the best possible signal to noise ratio by the proper setting of the Input Gain control. A maximum gain of (+)48dB and attenuation of (-)6dB is the range available.

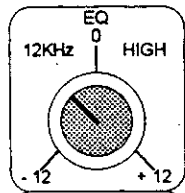

EQUALIZER

Four bands of equalization are available in each channel of the Phantom console. Use these controls to adjust the tonal characteristic of your sound.

A boost or cut of (+/-)12db is the gain range. Both the high and low bands are shelving type filters allowing the spectra above and below audibility to be controlled.

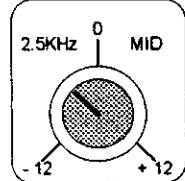

HIGH

Center frequency for the High EQ section is 12KHz. Use this band to adjust the brightness of the sound.

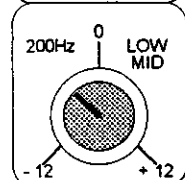

MID/LOW MID

Two mid-band frequencies are available for adjustment, Mid and Low-Mid. The Mid frequency center is 2.5KHz, and the Low-Mid center frequency is 200Hz.

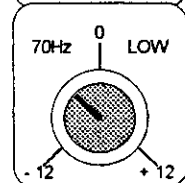

LOW

This shelving type filter adjusts the Low frequency range from approximately 20Hz to 70 Hz with a center frequency of 35 Hz.

EQ NOTES:

- 1) When the pot is set at 12 o'clock, that EQ band is bypassed.
- 2) When an EQ pot is positioned at a 9 o'clock setting, the result is a (-)5dB cut in gain. Setting the EQ pot to the 3 o'clock position results in a (+)5dB boost in gain. The pot tapers increase the controllability of the EQ in the mid gain positions, and limits any noise from an outside source the EQ may bring up.
- 3) The EQ center frequencies and bandwidths were chosen to allow detailed tailoring of specific musical material while preventing audible side effects like ringing.
- 4) Boosting EQ settings can substantially increase your channel gain. After EQing, if you see your channel Clip LED on, turn down the Input Gain pot of that channel until the Clip LED shuts off.
- 5) Cutting (rolling off) EQ settings will decrease your channel gain. After EQing, Solo the channel and

make level adjustments with your Input Gain pot (turn it up) so the Clip LED just comes on with the loudest (peaks) portions of the input source. Now, turn down the Input Gain so the Clip LED stays off.

MONITOR SEND

The Monitor Send section of the Phantom allows you to send four (4) Pre-Fader mixes to individual outputs on the rear panel. Each of the four outputs has its own master level controls (Monitor Sends in the Output Control Section) and are intended to be used as Monitor mixes in a live application.

A signal controlled by the Monitor Send section of the channel (labeled MONITOR) allows you to send the signal (bus) directly after the EQ section to the 1/4" Monitor Send jacks on the rear panel. The signal is Pre-fader, that is, the Channel Fader has no effect on the signal level of the Monitor Send. You can assign the signal to two of four monitor send buses with the Monitor Select Switch.

The Monitor Sends may also be made to be Post-Fader Sends. Removal of the face plate (14 screws and the fader knobs) and the repositioning of a jumper is required. For detailed instructions on changing the routing of the Monitor Send, see the MON/AUX Notes section.

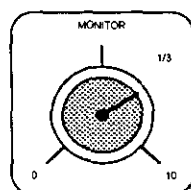

Monitor 1/3 Control

Sets the signal level sent to the 1 or 3 Monitor Bus. The signal will be controlled by the corresponding Master Monitor Send pot and be present at the Monitor Send 1 or 3 jacks on the rear panel.

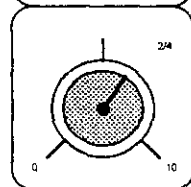

Monitor 2/4 Control

Sets the signal level sent to the 2 or 4 Monitor Bus. The signal will be controlled by the corresponding Master Monitor Send pot and be present at the Monitor Send 2 or 4 jacks on the rear panel.

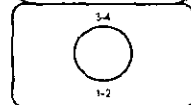

Monitor Select Switch

Selects which Monitor Bus the signal is sent to. When the switch is out (up), the Monitor pot sends the signal to Monitor Bus 1 and 2. With the switch in (down), the

Monitor pot sends the signal to Monitor Bus 3 and 4.

AUX (AUXILIARY) SEND

The Auxiliary Send section of the Phantom allows you to send signal from individual channels to 4 Post-Fader outputs on the rear panel. These four outputs have individual Master Level controls and are intended to be used as Effects Sends in a studio or live situation.

The Auxiliary Send section of each Input Channel (labeled AUX) allows you to send signal, from a point directly after the Channel Fader, to the Aux Send jacks on the rear panel. The signal is Post-Fader, which means that the Channel Fader's position influences the level being sent to the Auxiliary Bus. You can assign the signal to 2 of the 4 Auxiliary Send buses with the Auxiliary Select Switch. For detailed instructions on changing the routing of the Auxiliary Send, see the MON/AUX NOTES section.

NOTE: Normally, the audio signal is post fader, there will only be level sent to the assigned buses if the Channel Fader is up.

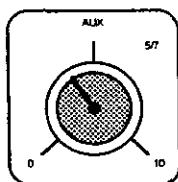

Auxiliary 5/7 Control

Level adjustment for signal sent to the 5 or 7 Aux Bus. The Channel signal is sent to the corresponding Master Aux Send pot and the Aux Send jacks on the rear panel.

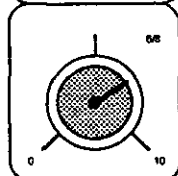

Auxiliary 6/8 Control

Level adjustment for signal sent to the 6 or 8 Aux Bus. The Channel signal is sent to the corresponding Master Aux Send pot and the Aux Send jacks on the rear panel.

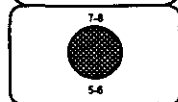

Auxiliary Select Switch

Selects which Auxiliary Bus the signal is sent to. When the switch is up, the Aux pots send signal to Aux Bus 5 and 6. When the switch is depressed (in), the Aux pots send signal to Aux Bus 7 and 8.

MON/AUX NOTES

- 1) The Monitor pots are switch selectable between buses 1,2 and 3,4.
- 2) The Monitor pots are internally jumper selectable to be pre or post fader.
- 3) The AUX pots are switch selectable between buses 5,6 or 7,8.
- 4) The Aux pots are internally jumper selectable to be pre or post fader.
- 5) Changing the jumpers for PRE/POST :

REMOVE AC PLUG FROM AC MAINS RECEPTACLE! Be sure power is disconnected from your PHANTOM CONSOLE if you remove the lid. Remove the fourteen screws holding the cover to the chassis. There are eight screws on the top (six small, two large) and six large screws along the front and rear panel (three each end). Remove the fader knobs. Lift off the cover.

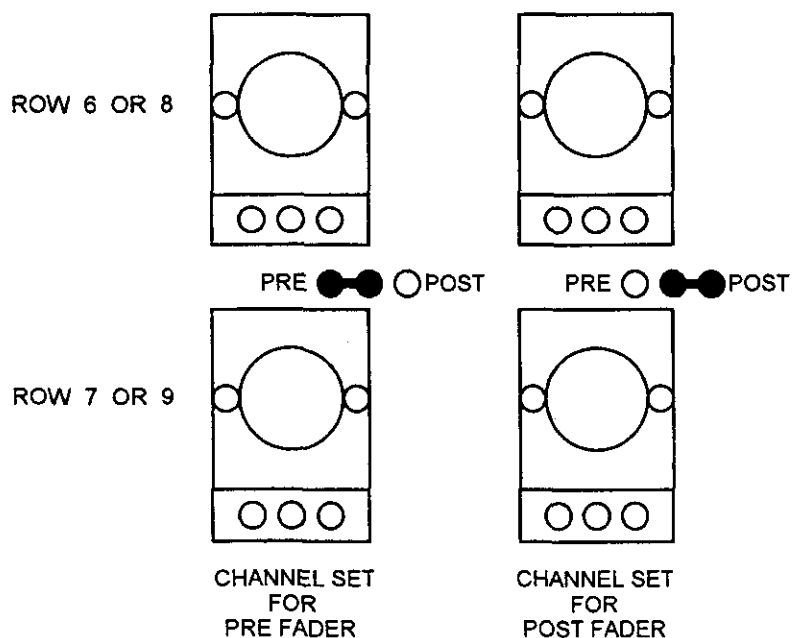

The jumpers are located between the sixth and seventh row of pots (Monitor), and eighth and ninth row of pots (Auxiliary). When the jumper connects the center and left post, the send is PRE fader. When the jumper covers the center and right post, the send is POST fader.

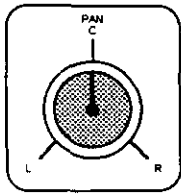

PAN

The pan control allows you to set the signal anywhere left or right in the stereo field on either the Master or Subgroup Bus. When the pot is set fully to the left, signal is present only on the Left channel of the bus. Setting the pot fully to the right sends signal only to the right bus. Centering the pot sends an equal amount of signal to the left and right outputs. The pan pot has a constant image taper. This means as you fade from left to right, the left channel is faded out and the right channel increases in gain proportionally.

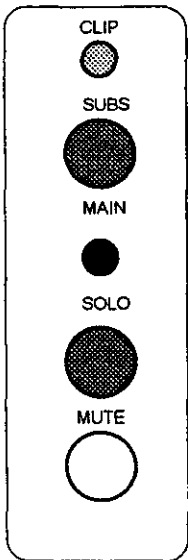

CLIP LED

When too much signal is present in the channel this LED will light. Its position in the audio signal path is directly after the EQ section. If the LED is lit, lower the level of the Input Trim control. Also, check your EQ pots to make sure you're not boosting the frequencies unreasonably.

MAIN/SUB SELECT SWITCH

This switch assigns the signal in the channel to be routed either to the Main or Subgroup Bus. With the switch in, signals are routed to the Subgroup Bus. When the switch is in the out position, signal is sent to the Main Bus.

SOLO/MUTE LED

The Solo/Mute LED indicates if the signal in the channel is being routed to the Solo circuit or if the channel is Muted. If the LED is at full brightness, the signal is being sent to the Solo Circuit. When the LED is at half brightness, the channel has been muted.

SOLO

The Solo function allows you to monitor single or multiple input channels without disturbing other settings on the console.

Soloing (depressing the SOLO switch) a channel sends the Pre-Fader signal directly to the Control Room Output, and Headphone Output without affecting the Mono and Main L/R outputs. When a Solo switch is depressed, all other audio is muted to these outputs. This is helpful when you wish to check the output of a particular channel or group of channels without disrupting the rest of a mix. The soloed signal is also sent to the Output Meters. This is helpful when setting input levels.

Adjust the Solo monitor level with the SOLO Level pot located in the Master Section of the console.

MUTE

The Mute switch cuts off (mutes) the channel signal to all audio buses except the solo bus. When the switch is in, Mute is engaged.

SOLO/MUTE NOTES

1) The Mute and Solo circuits are located after the EQ section. EQing can be monitored when a

channel is soloed.

- 2) The Mute switch is located after the Solo switch in the signal chain. This allows a Muted channel to be Soloed.
- 3) The Mute and Solo circuits are located after the Clip indicator. Clipping is indicated on Muted and Soloed channels.
- 4) The Mute function precedes the Pre-Fader sends. This ensures that unwanted signals are not sent to Monitor mixes.
- 5) Independent/adjustable Solo monitor level is provided to protect speakers and ears from harmful volume levels.

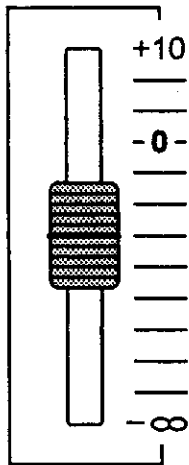

CHANNEL FADER

The Channel Fader sets the final signal level of the channel before it is sent to the audio buses. Level range is (-) infinity (no level) to (+) 10dB of gain. A nominal (Unity gain or 0dB) setting is indicated by the number 0. The 0 level is the cleanest setting for the Fader (no boost or cut).

When setting levels: It is good practice to keep the Channel Fader at or below the nominal (0) setting. If you find that you are using a channel with the Fader set well above 0, you probably have the Input Trim set too low. Although additional gain is available through use of the Faders, it is best to use this gain only after you have optimized the Mic/Line Input gain. (see Input Gain)

LINE INPUT CONTROLS (8X2 SUBMIXER)

Located at the upper right hand section of the Phantom are eight (8) Line Inputs. These inputs can be used for: line level inputs where EQ is not needed (i.e. Keyboards, samplers), effect-returns, 8 track tape return, or as an 8 X 2 "submixer". There are 1/4" unbalanced inputs located on the rear panel labeled "LINES IN". Input Level control, Panning and Soloing may be done with the Line Inputs. All of the outputs sum into a stereo output located on the rear panel (17-24 Out Sum to Stereo). The stereo output can be routed to the Mains, Subs or both (and of course OFF), while always being sent to the special line mix outputs. The power here is not just the 8 inputs but the ability to re-configure this section to the application.

******(See application notes on how to bring this output back into the console to utilize Mon/ Aux sends and EQ).

1608/3208 NOTES

- 1) 1608 8X2 Line Inputs are: 8-16
- 2) 3208 8X2 Line Inputs are 24-32

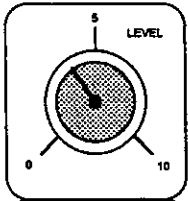

LEVEL

The Level control allows you to adjust the incoming signal level to the Channel. Since there are no Clip indicators for the Line Ins, it is good practice to use the SOLO function when setting the input level to these channels to optimize input gain and to prevent accidental overload of the input stage.

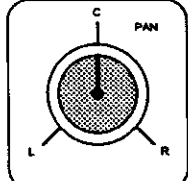

PAN

The Pan control allows you to place the signal anywhere in the stereo field. When the pot is set fully to the left, signal is only present on the left output (or Bus). When the pot is set fully to the right, signal is only present on the right output (or Bus). When the pot is centered, equal amounts of signal are sent to the left and right outputs (Buses). Pan works directly with the "Line In Assign" function. The Line In Assign selects which stereo bus a signal is to be sent to. (Mains, Subs, or both) The Pan pot controls which "side" (left or right or both) of the bus you wish to route the signal.

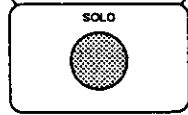

SOLO

Pushing in the Solo Button routes the signal in the channel to the Solo circuit. The solo circuit allows just the channel being soloed to be heard at the Control Room and Headphone Outputs. When you depress the switch to Solo the channel, the audio signal is sent directly to the Control Room Output, and Headphone Output without affecting the Mono and Main L/R outputs. When a Solo switch is depressed, all other audio from all channels is muted to these outputs. This is helpful when you wish to check the output of a particular channel or group of channels without disrupting the rest of a mix. The soloed signal is also sent to the Output Meters.

MASTER CONTROL SECTION

MASTER/OUTPUT/TAPE/LEVEL/CONTROL

All routing of the "mixed" signals to the appropriate outputs, buses, and metering is maintained by this section. Incoming signals, such as 2-track (cassette), and Talkback Microphone levels are set and assigned in this section.

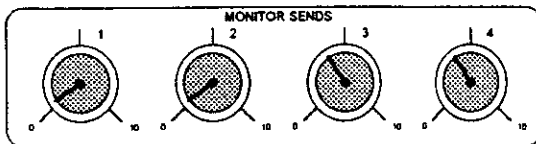

MONITOR SENDS

Sets the master level of Monitor Sends 1 through 4. The signal is sent to the Monitor Send jacks on the rear panel.

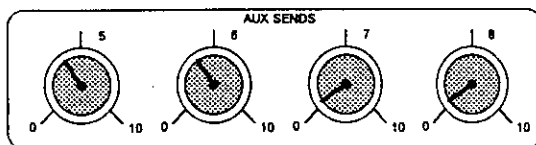

AUX SENDS

Sets the master level of Aux sends 5 through 8. The signal is sent to the Aux Send jacks on the rear panel.

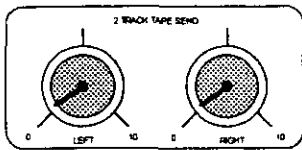

2 TRACK TAPE SEND

Controls final level sent to the 2-Track Tape Send Output jacks. The 2-track output jacks, whose source is the Sub L/R output, allow the user another low level (-10dB) output with separate left and right controls.

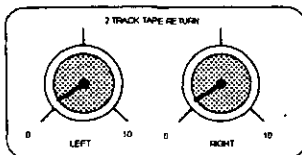

2 TRACK TAPE RETURN

Allows you to adjust the level of the incoming tape signal. Signal is routed directly to the Main Left and Right Bus. Signal source is the 2 TRK TAPE RETURN (1/4") jacks on the rear panel.

TWO TRACK NOTE:

1) The 2 Track Return may be used as two additional inputs with a level control direct to the Main L/R Bus.

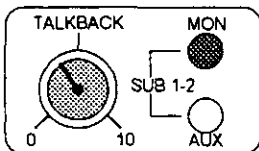

TALKBACK

The talkback section allows the user to plug a mic into a 25th input and route it to either the Monitor, Auxiliary, or Subgroup 1 & 2 buses. Applications for Talkback include studio/ stage talkback and cue print to tape. Level and Bus Assign controls are provided. Adjust the microphone input signal with the

Talkback pot. When the MON switch is depressed, the signal is sent to the Monitor bus. The AUX switch sends the signal to the Auxiliary bus. When both switches are depressed the talkback signal is sent to Subgroups 1 and 2 (SUBS L/R).

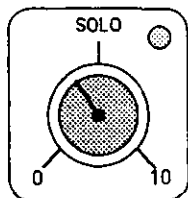

SOLO

The SOLO function allows you to set input channel levels via the output meters, and listen to individual or summed inputs via the control room or headphone outputs. This separate SOLO level pot assures the un-initiated user no blasting loud levels as a channel is soloed. The setting of the pot does not affect the LED meter. When ANY channel is soloed, the mains signal in the control room is automatically muted. When

the LED is lit, it indicates a channel is being soloed.

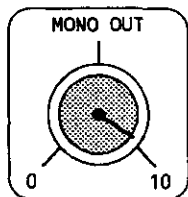

MONO OUT

When using the Phantom as a live mixing console, the final output level of the four Subgroups are controlled by the MONO OUT pot. The output level potentiometer (pot) used to feed the summed output of the four (4) Subgroups to a mono source for amplification or recording. This output is intended for use with mono PA systems.

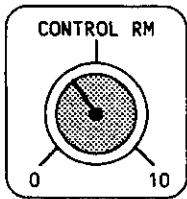

CONTROL ROOM

An output level potentiometer (pot) used to feed the final stereo output of the console to the control room amplifier and speakers. The Control Room output is located after the Mains L\R Faders. The position of the Mains L\R Faders has a direct influence on the level sent to the Control Room Output, however, the Control Room output setting does not affect the Main Out level. Use the Meter Select Switch to select the source for the Control Room.

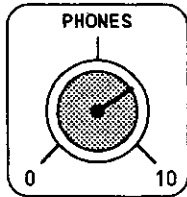

PHONES

Set the level of your Headphones with this control. Use the Meter Select Switch to select the source for the Phones.

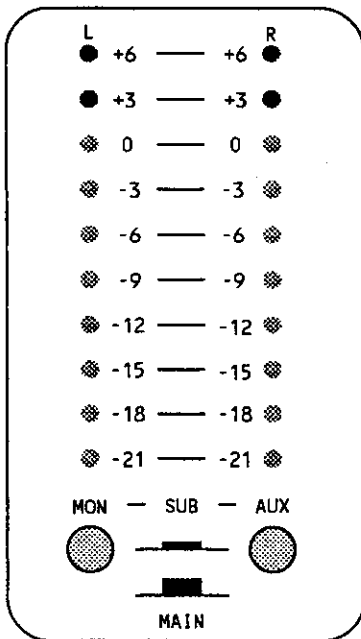

LEVEL METER

A ten step LED meter keeps you informed of your selected signal level at all times. The switchable ten step LED Meter allows the user to select and view the audio signal level of the Mains L\R, Subs L\R, Monitor, Auxiliary and Solo buses and the Input channels. Meter switching is provided through use of the two Meter Assign Switches and the Solo function. When the two Meter Assign Switches are up (normal position), the Meter displays the output of the Mains L\R bus. When the MON switch is depressed the Meter displays the output of the Mon 1 and 2 buses. When the AUX switch is depressed the Meter displays the output of the 5 and 6 buses. When both the MON and AUX switches are depressed, the Meter displays the output of the Subs L\R buses. When a Solo switch is depressed the Meter automatically displays the Solo bus. Channel signal level can be assigned to the Meter by use of the Solo function.

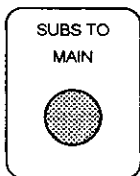

SUB TO MAIN

This switch sends the Subs Left/Right Output to the Mains Left/Right Bus. When the PHANTOM is used in a stereo application, depressing the Subs to Main Switch allows for the two subgroups (1L and 2R) to be assigned to the Mains L/R (Main Output). When using all four subgroups in a mono application, the switch will be out.



LINE IN ASSIGN

The Line In Assign switches assign the stereo output of the eight Line Inputs to the Mains L/R, the Subs L/R or both buses. When neither of the switches are depressed the stereo output of the eight Line Inputs are not assigned to any bus. When the SUBS switch is depressed the stereo output is sent to the Subs L/R buses. When the MAIN switch is depressed the stereo output is sent to the Mains L/R buses. When both the SUBS and MAIN switches are depressed the stereo output of the eight Line Inputs is sent to both the Subs L/R and Mains L/R buses. The stereo output is always present at the rear panel jacks (17-24 Out Sum to Stereo).

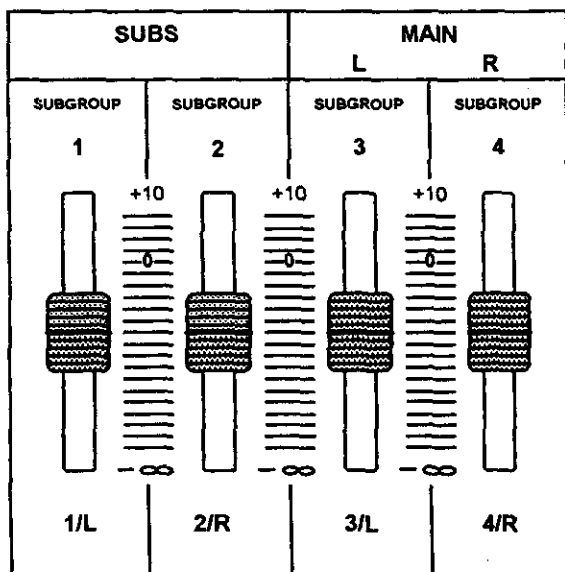

MASTER FADERS

All channels are sent to the Main Bus unless they are assigned to Sub Groups. If channels are assigned to Sub Groups (Subs L/R), the Sub Groups then have to be assigned to the Main Outputs (Mains L/R). The Master Faders control the output level of the Subs L/R and Mains L/R. The Subs L/R faders control the final output level of the channels assigned to the Sub bus. The Mains L/R faders control the output level of the channels assigned to the Main bus and the final output level of the console.

REAR PANEL CONNECTIONS

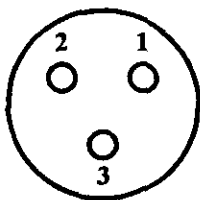

MIC INPUTS

Each channel input has an XLR (female) balanced mic input with a gain potential of up to 48dB. Input impedance is 2.4K ohms and is intended for low impedance microphones. Phantom power is available to Ch 1-8 for use with condenser microphones. A voltage of 48 Volts is applied to pins 2 and 3 when the Phantom Power Enable switches are pushed in on the rear panel. Two phantom power switches control Ch 1-4 and Ch 5-8 separately. When using unbalanced lines to the mic ins, make sure phantom power is switched off.

VERY IMPORTANT NOTE: PIN CONFIGURATION FOR THE FEMALE XLR MIC INPUTS ARE: PIN 1 GROUND, PIN 2 (+) [HOT] AND PIN 3 (-) [COLD]. PLEASE MAKE SURE YOUR CABLES ARE WIRED IN THIS CONFIGURATION, OTHERWISE, YOU WILL CREATE NOISE IN YOUR SYSTEM.

BALANCED LINE INPUTS

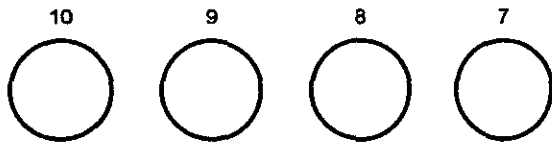

balanced line input signals and high impedance mics. Gain is adjustable via the Pad control. The input impedance is 2.4K ohms.

BALANCED LINE INPUTS

For each channel input there also is a 1/4" phone jack (T.R.S.) balanced Line Input. The configuration of the jack is Tip (+) [Hot], Ring (-) [Cold], and Sleeve is Ground. These inputs are intended to be used for

1608/3208 NOTES

- 1) 1608 Balanced Line Inputs are 1-8
- 2) 3208 8X2 Balanced Line Inputs are 1-24

LINE INPUTS

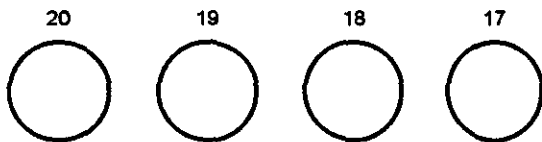

LINE INPUTS 8X2

Unbalanced line level inputs intended to be used for effects returns, cue mix, extra inputs, etc. Summation of the 8 inputs is available on two rear panel output jacks, and assignable to the Main and/or Sub buses.

MONITOR SEND

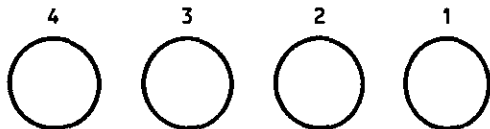

MONITOR SEND

The monitor sends are low impedance unbalanced outputs which send the final monitor mix to the next stage of the system. Monitor sends are usually intended for pre-fader mix but, the Phantom Series Consoles can be configured for post-fader sends as well.

AUX SEND

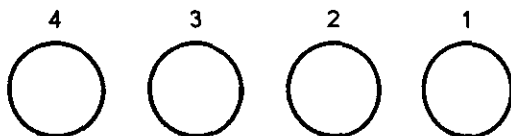

AUX SEND

The auxiliary sends are low impedance unbalanced outputs which send the final auxiliary mix to the next stage of the system. Normally intended for use as effects sends but input channels can be set for pre-fader sends as well.

CHANNEL INSERTS

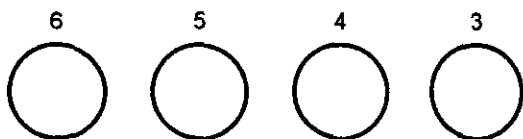

CHANNEL INSERTS

Each channel has an unbalanced, line level insert point between the mic amp and the EQ where external dynamics devices may be introduced to the mixer after the input gain stage. This also is the cleanest way to get a line level input into the mixer (as long as you don't need the pad to control gain). The Insert jack is configured to both send and receive the signal. Using a stereo (Tip, Ring, Sleeve) setup, the Tip is the Receive (input), Ring is the Send (output), and Sleeve is ground. The input impedance for the Receive is 2.5K ohm, and the Send is 100 ohms. The tip is the input, the ring is the output. If you insert a 1/4" plug in half way, you get an output from the Mic amp without interrupting the signal.

The insert jack is configured like the following diagram. To make an insert cable, wire it as shown in the picture. Use shielded cable, even though the diagram doesn't show it, it has to be there!

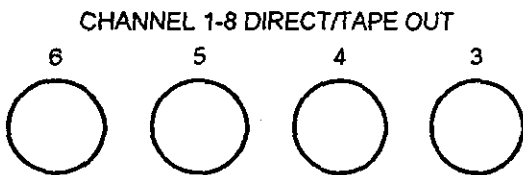
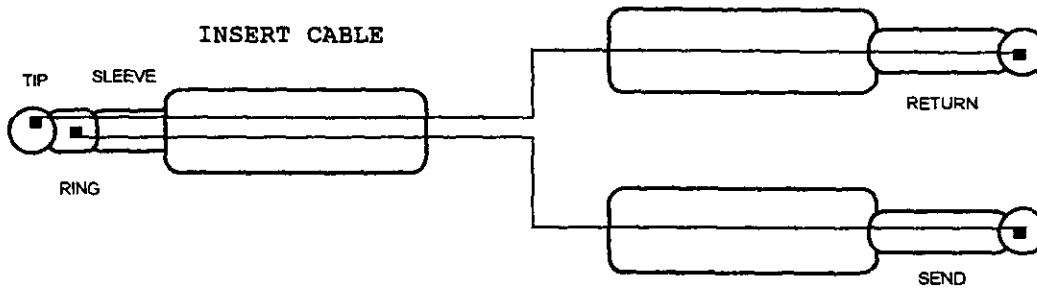
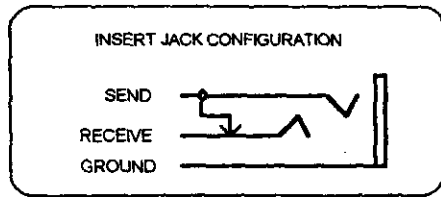

CHANNEL 1-8 DIRECT /TAPE OUT

A direct channel out for the first eight channels is available. This direct out is post fader and is useful for sending the signal directly from a channel to multitrack tape decks. Another use would be as additional post fader sends.

1608/3208 NOTES

- 1) 1608 Direct/Tape Out Channel 1 through 8
- 2) 3208 Direct/Tape Out Channel 1 through 16

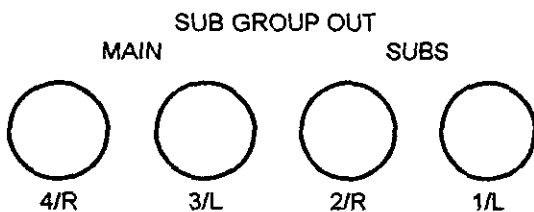

SUB-GROUP OUT

Anytime you mix to a subgroup, the subgroup mix is output through the Sub Group Outputs 1L, 2R 3L, and 4R. The Subgroup outputs are unbalanced low impedance 1/4" phone jacks. For Stereo operation, the 3/L and 4R output jacks are configured to be the Main Output jacks.

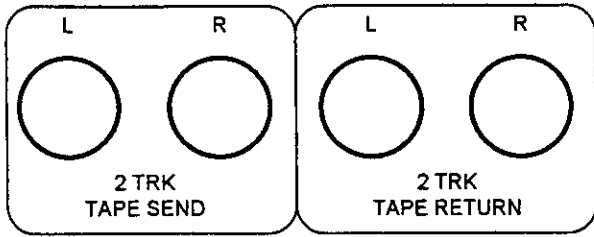

2 TRACK TAPE SEND AND RETURN

Left and right stereo, low impedance, unbalanced, line level, 1/4" phone jack outputs are provided for sending the Sub L/R output directly to a 2 Track recorder. Adjust the 2 Track Tape Send Level controls to set the audio level sent to the recorder. A left and right unbalanced, high impedance 1/4" phone

jack 2 Track Tape Return is provided to input the output of a two track directly onto the Main Left and Right Bus.

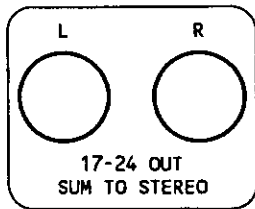

17-24 OUT SUM TO STEREO

The summed levels of the eight Line Inputs (17-24) is available as a Left and Right stereo output for the eight line inputs and is assessable via the two 1/4" unbalanced, low impedance output jacks.

1608/3208 NOTES
 1) 1608 Summed Line Inputs are 8-16
 2) 3208 Summed Line Inputs are 24-32

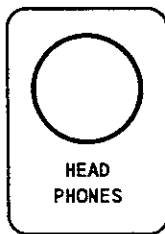

HEADPHONES

The audio output at the Headphone Jack is whatever the meter select switch has been set to. Headphone level is controlled with the Phones level pot. A Stereo (Tip, Ring Sleeve) 1/4" jack with an output impedance of 150 ohms is located on the rear panel. Select the signal source with the Meter Select Switch (Main, Subs, Mon1/2, or Aux 5/6). If you solo a channel, only that signal (the solo signal) will be present in the headphones.

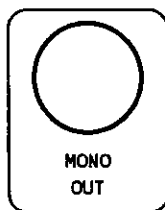

MONO OUT

An unbalanced 1/4" phone jack, low impedance line level signal intended for use as the Main P.A. feed in a live application. Signal source is the summation of the Main L+R and Sub L+R, and is unaffected by Subs to Main switch.

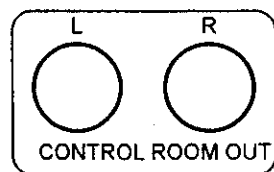

CONTROL ROOM OUT

The output at the Control Room Jacks is whatever the Meter Select switch has been set to. Control Room level is controlled with the Control Room level pot. The jacks are 1/4" unbalanced phone jacks with an output impedance of 150 ohms. The signal source is the same as the Headphone output. Select the signal source with the Meter Select Switch (Main, Subs, Mon1/2, or Aux 5/6). If you solo a channel, only that signal (the solo signal) will be present at the Control Room Outputs.

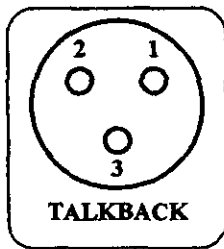

TALKBACK

The Talkback Mic Input is a high impedance unbalanced XLR connector located on the rear panel. You may route the signal to Mon 1-4, Aux 5-8, or Sub L/R buses. Use the talkback to communicate through the Monitors or Auxes to performers. When Talkback is assigned to the Subs, you may use it for "printing to tape". You may use high or low impedance, dynamic or self powered microphones with the Talkback Mic Input.

TALKBACK NOTE:

- 1) Use the talkback input to check any external effects patched through your auxiliary outs.

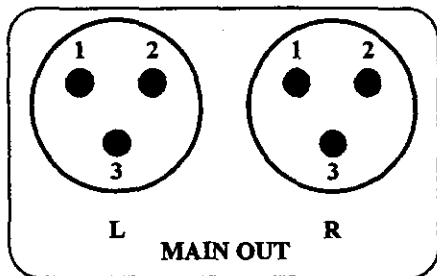

MAIN OUT L/R (XLR)

The Main output of the mixer is provided at the left and right Main Output male XLR connectors on the rear panel. These outputs are balanced with an output impedance of 600 ohms.

VERY IMPORTANT NOTE: PIN CONFIGURATION FOR THE MALE XLR MIC INPUTS ARE: PIN 1 GROUND, PIN 2 (+) [HOT] AND PIN 3 (-) [COLD]. PLEASE

MAKE SURE YOUR CABLES ARE WIRED IN THIS CONFIGURATION, OTHERWISE, YOU WILL CREATE NOISE IN YOUR SYSTEM.

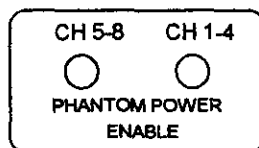

PHANTOM POWER ENABLE SWITCHES

To enable Phantom power to the Mic Input Channels you must access the enable switches on the rear panel. One switch enables channels 1-4, and the other enables channel 5-8. These switches are recessed below the panel to protect your settings. Simply insert a pen point or other such implement to toggle the switches on or off. When the switch is in, phantom power is enabled, with the switch out, phantom power is disabled.

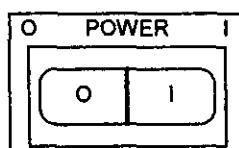

POWER SWITCH

The power switch turns the power on and off to the mixer. Your Phantom Series Console may be left on continuously or you may turn it on and off as needed. Remember to always turn the mixer on before your effects processors and power amplifier if you choose to power on and off. "O" indicates off and "I" indicates on.

POINTS OF INTEREST TO USE WITH YOUR PHANTOM SERIES CONSOLE

HOME RECORDING

The basic home recording mixer is required to mix a small number of microphones down to a limited number of audio outputs. A means of returning a multiple tracks for bouncing and subsequent mix down to two tracks is also a requirement. Both pre-fader and post-fader sends are needed in limited quantity. Pre-fader sends are primarily used for monitor mixes and post-fader sends for effects. A Solo bus is used for listening to individual channels and setting pre-fader operating levels. Mute switches allow individual channels to be turned off without touching any other levels. Direct outputs allow the user to connect the mixer to a much larger multitrack-track. Channel inserts provide access to individual inputs for added signal processing. A Talkback mic is used for communicating from the "control" room to the musicians' monitor mix. It is also used for printing to tape.

LIVE USE

Live use changes the application of some of the mixer features. Generally, more pre-fader mixes are required. Virtually all of the inputs will be used, and generally with microphones. Most P.A.s require a mono output. Sub mixes are used to easily adjust groups of input channels. The solo and mute functions are definitely a requirement here as is the talkback.

Compared to other lower cost mixers, the output section of the mixer shines. Your Phantom Console has the ability to route input channels to any of 4 main buses. The second (SUB L/R) stereo output bus can be summed through a switch to the main outputs. All 4 buses to drive a MONO output (including its' own level pot) for use with a P.A.

APPLICATIONS STRENGTH

P.A. ideas

P.A. is one of the strengths of the Phantom Console. It can process 16 mic and 8 line inputs at once. (The 3208 has 24 mic inputs!) The number of mic inputs is what separate the consoles intended for home recording vs. those intended for live use.

The MONO output is another indicator of a mixer that is ready for live use applications. Since most P.A.s are mono, this is virtually a requirement. It also allows the mixer main buses to act as sub-mixes. This allows the user to assign drums to say Sub-L, and fade only the drums in the mono mix by using the Sub-L fader.

Live use also demands lots of pre-fader sends for monitor mixes. Phantom Series Consoles can provide up to 4 monitor mix pots per channel and up to 8 mixes on the output of the mixer. The user can determine the configuration by moving the internal jumpers on each input channel.

Applying the Phantom series mixers as "monitor" boards can provide up to 12 outputs and 6 independent mixes.

The last 8 inputs of the Phantom Series Consoles can be used for either effects returns, or keyboard sub-mix. It can be "muted" by not assigning the output to either Mains or Subs. These inputs also have individual SOLO switches.

Mutes and solo's are configured for optimal live use. The mutes are the equivalent of totally killing an input channel and all of its sends. The monitor mixer can use the headphone or control room output to hear soloed channels even if they are muted. Both mute and solo are indicated on each channel by an LED. The LED glows dim for MUTE, and bright for SOLO.

Recording ideas

The 8x2 mix section is great for multitrack-track recorder output returns. It can provide a cue mix for an 8 track and can be switched onto either the Mains or Subs. If assigned to the Subs, when the meters are switched to monitor the subs, the control room output follows this selection and you hear the 8-track mixdown at the push of a button!

This section even has its own output so you could connect the line 8X2 output to the input of a 2-track recorder and return the 2-track outputs to the 2-track receive jacks with no possibility of feedback.

The cleanest way to route inputs to outputs is to use the Direct outs. They also allow a mixer to work with a large multitrack-track recorder. Not going through a mix bus allows the signal to bypass a lot of circuitry. When the signal passes through less stuff, it avoids picking up additional noise, distortion and crosstalk. The cleanest way into the mixer is to use the channel insert as an input! this bypasses the Mic amp and Pad circuit, while still allowing processing by the EQ.

You could consider returning effects via the last eight line inputs but, it is more versatile to return them through input channels. This allows you to apply EQ to reverbs, route effects to the appropriate bus (Subs or Mains) and mute then with the push of a button.

SPECIFICATIONS

IMPEDANCES:

INPUT

MIC	2.4K ohms
BALANCED LINE	8.4K ohms
CHANNEL INSERT	5.0K ohms
LINE	2.5K ohms
TAPE RETURN	5.0K ohms

OUTPUT

MAIN BALANCED (XLR)	600 ohms
MAIN and SUB (1/4")	150 ohms
CHANNEL INSERT	100 ohms
DIRECT	100 ohms
MONO	150 ohms
CONTROL ROOM	150 ohms
TAPE SEND	150 ohms
HEADPHONES	150 ohms

MAXIMUM LEVELS (0dBu = .775V RMS)

INPUT

MIC	(+)14dBu
BALANCED LINE	(+)24dBu
LINE	(+)24dBu
2-TRACK	(+)24dBu
TALKBACK	(+)20dBu

OUTPUT

MAIN BALANCED (XLR)	(+)26dBu
MAIN and SUB (1/4")	(+)22dBu
CHANNEL INSERT	(+)22dBu
DIRECT	(+)22dBu
MONO	(+)21dBu
CONTROL ROOM	(+)21dBu
TAPE RETURN	(+)22dBu
HEADPHONES	180mW/Ch

THD (600 ohm source, clip light dim) 20Hz-20KHz

MAXIMUM (max gain, 0dBu out)

MIC IN TO MAIN L OUTPUT	0.025%@1KHz
-------------------------	-------------

TYPICAL

MIC IN TO MAIN L OUTPUT	0.007%@1KHz
-------------------------	-------------

CMRR

MIN GAIN (6dB)

60Hz.	73dB (Mic), 52dB (Line)
-------	-------------------------

1KHz	76dB(Mic), 52dB (Line)
------	------------------------

MAX GAIN (48dB)

60Hz.	70dB (Mic), 56dB (Line)
-------	-------------------------

1KHz.	74dB (Mic), 56dB (Line)
-------	-------------------------

FREQUENCY RESPONSE (+0,-1dB)

MIC IN TO MAIN OUT	14Hz to 22KHz
BALANCED LINE INPUT TO MAIN OUTPUT	13Hz to 21KHz
TWO TRACK INPUT TO MAIN OUTPUT	11Hz to 42KHz

GAIN (all faders full, channels assigned subs to mains)

MAX FROM MIC IN TO BALANCED OUTPUT	100dB
MIC	46dB
BALANCED LINE IN	36dB
CHANNEL FADER	10dB
L/R MASTER (SUB)	10dB
BALANCED OUT	6dB

NOISE (E.I.N.) (in dBu)

MIC INPUT NOISE (shorted , fader at 0dB)	
@ Min Gain (6dB)	(-)102
@ Mid Gain (20dB)	(-)115
@ Max Gain (47db)	(-)131
MIC IN TO MAIN OUT (main output noise)	(-)93
MIC IN TO CONTROL ROOM OUT	(-)89
HEADPHONES	(-)98
MONO OUTPUT	(-)96
MON/AUX OUTPUT (all channels assigned)	(-)105

DYNAMIC RANGE

MIC IN TO MAIN OUT	115dB
CONTROL ROOM	112dB
HEADPHONES	115dB
MONO OUTPUT	113dB

CROSSTALK

MAIN L TO MAIN R	92dB@1KHz
MAIN L TO SUB L	85db@1KHz
CONTROL ROOM L/R	73dB@1KHZ
HEADPHONE L/R SEPARATION	74dB@1KHz
MIC INPUT CH 3 TO CH 4 (shorted @ max gain)	93Db@1khZ

POWER REQUIREMENTS

95 TO 125 VOLTS AC, 500ma, 55W TYPICAL (MODEL 602--2408) . PROTECTION: INTERNALLY FUSED, 1A SLO-BLO. (current and power consumption slightly lower for model 601--1608, and higher for model 603--3208)
PRODUCTS MANUFACTURED FOR USE OUTSIDE THE UNITED STATES ARE CONFIGURED FOR COUNTRY OF DESTINATION

DIMENSIONS

19.25"H, 19.0"W, 8.0"D, 32LBS (MODEL 1608, 2408)
19.25"H, 28.5"W, 8.0"D, 40LBS (MODEL 3208)

DUE TO CONSTANT PRODUCT EVALUATION AND POSSIBLE IMPROVEMENT, SPECIFICATIONS ARE SUBJECT TO CHANGE WITHOUT NOTICE.

COPYRIGHT 1992, ALL RIGHTS RESERVED, APPLIED RESEARCH & TECHNOLOGY, INC.

WARRANTY & SERVICE INFORMATION

LIMITED WARRANTY

Warranty service for this unit will be provided by Applied Research & Technology, Inc. in accordance with the following warrant statement.

Applied Research & Technology, Inc. warrants to the original purchaser that this product and the components thereof, will be free from defects in workmanship and materials for a period of one year from the date of purchase. Applied Research & Technology, Inc. (ART) will, without charge, repair or replace, at its option, defective product or component parts upon prepaid delivery to the factory service department or authorized service center, accompanied by proof of purchase date in the form of a valid sales receipt.

EXCLUSIONS: This warranty does not apply in the event of misuse or abuse of the product or as a result of unauthorized alterations or repairs. This warranty is void if the serial number is altered, defaced, or removed.

ART reserves the right to make changes in design or make additions to or improvements upon this product without any obligation to install the same on products previously manufactured.

ART shall not be liable for any consequential damages, including without limitation damages resulting from loss of use. Some states do not allow limitation of incidental or consequential damages, so the above limitation or exclusion may not apply to you. This warranty gives you specific rights and you may also have other rights which vary from state to state.

For units purchased outside The United States, service will be provided by an authorized distributor of Applied Research & Technology, Inc.

SERVICE

The following information is provided for the unlikely event your unit requires service.

- 1) Be sure the unit is the cause of the problem. Check to make sure the unit has power supplied, all cables are connected correctly and the cables themselves are in working condition.
- 2) If you find the unit to be at fault, write down a description of the problem including how and when the problem occurs.
- 3) If you are returning the product to the factory, you must, call the factory for a Return Authorization (RA) number.
- 4) Pack the unit in it's original carton or a reasonable substitute. Print the RA number clearly under the address.
- 5) Include with your unit: a return shipping address (We cannot ship to a P.O. Box), a copy of your purchase receipt, a daytime phone number, and the description of the problem.
- 6) Ship the unit to:
APPLIED RESEARCH & TECHNOLOGY, INC.
215 TREMONT STREET
ROCHESTER, NY 14608
ATTN: REPAIR DEPARTMENT
RA # _____
- 7) Contact our customer service department at (716) 436-2720 for your Return Authorization number or questions regarding repairs. Customer Service hours are 9:00 AM to 4:00 PM Eastern Time, Monday through Friday.

OUR NEW AREA CODE IS 585

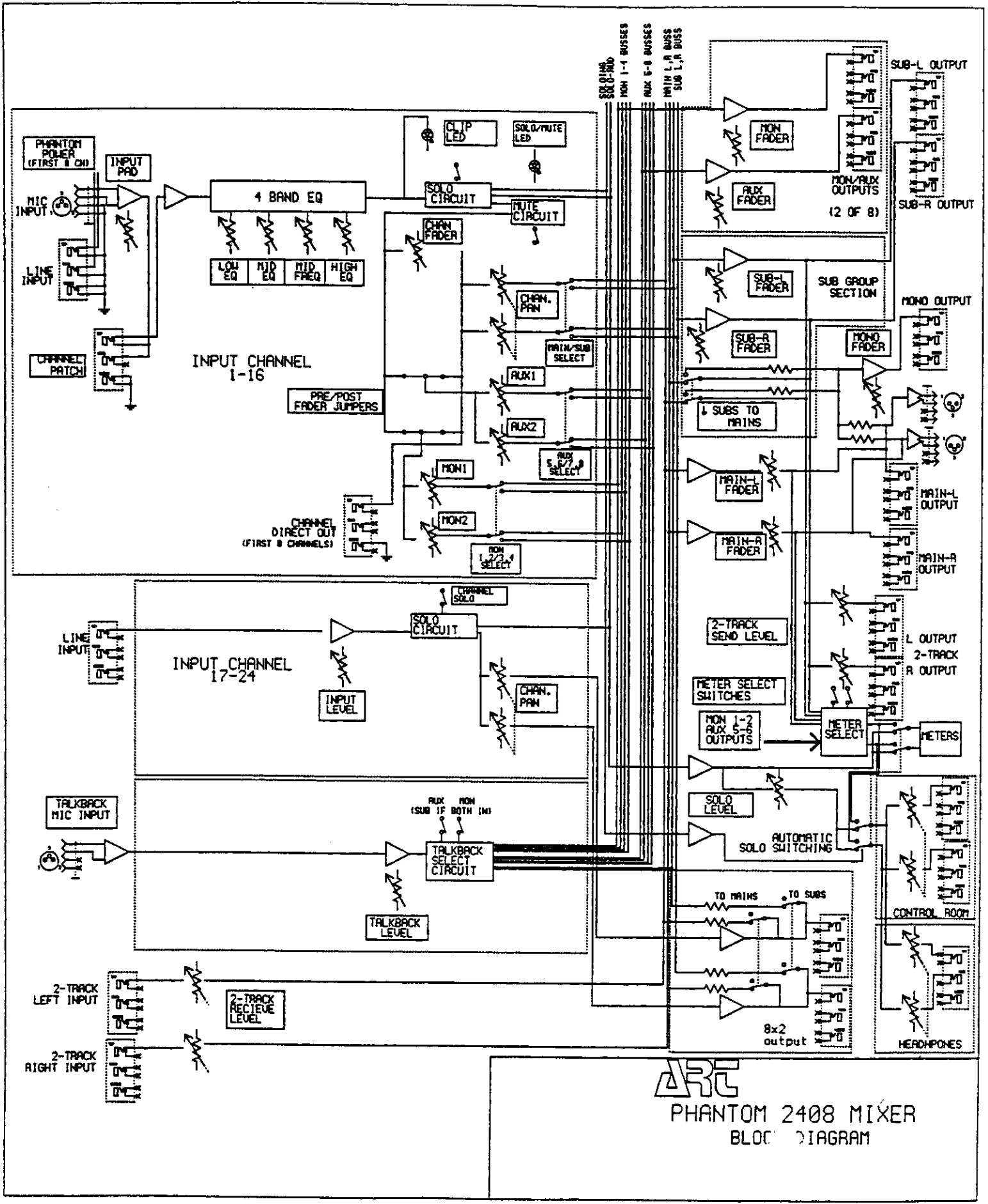

ARC
PHANTOM 2408 MIXER
BLOCK DIAGRAM